

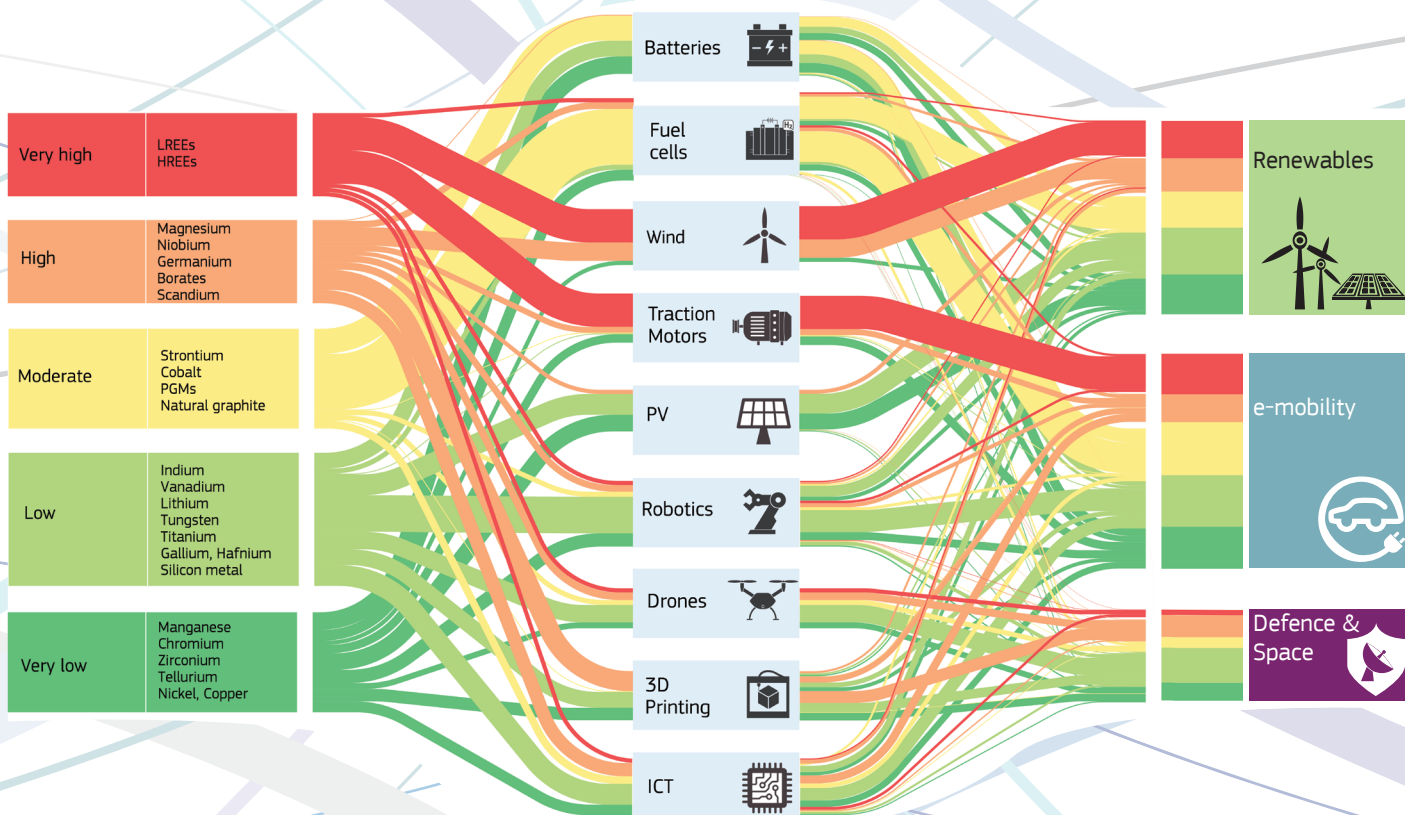

European
Commission

Critical Raw Materials for Strategic Technologies and Sectors in the EU

A Foresight Study



Main authors (European Commission, Joint Research Centre) by alphabetical order:
Bobba, S., Carrara, S., Huisman, J. (co-lead), Mathieux, F., Pavel, C. (co-lead).

Acknowledgements

Authors of the report would like to thank colleagues from GROW, especially Constanze Veeh, Milan Grohol, George Mörsdorf and Tatu Liimatainen, for their trust and guidance during the preparation of this report.

The inputs of the following JRC colleagues is also acknowledged: Fulvio Ardente, Darina Blagoeva, Gian Andrea Blengini, Konstantinos Georgitzikis, Thibaut Maury, Beatrice Plazzotta and Sara Andre.

Comments, questions and input can be sent by email to GROW-C2@ec.europa.eu

Neither the European Commission nor any person acting on behalf of the Commission is responsible for the use that might be made of the following information.

Luxembourg: Publications Office of the European Union, 2020

© European Union, 2020

Reuse is authorised provided the source is acknowledged.

Citation as "European Commission, Critical materials for strategic technologies and sectors in the EU - a foresight study, 2020"

The reuse policy of European Commission documents is regulated by Decision 2011/833/EU (OJ L 330, 14.12.2011, p. 39).

For any use or reproduction of photos or other material that is not under the EU copyright, permission must be sought directly from the copyright holders.

print: ISBN 978-92-76-15337-5 doi: 10.2873/865242 ET-04-20-034-EN-C

pdf: ISBN 978-92-76-15336-8 doi: 10.2873/58081 ET-04-20-034-EN-N

Critical Raw Materials for
Strategic Technologies and Sectors
in the EU

A Foresight Study

Contents

Executive Summary	7
1 Introduction	14
2 Critical raw materials in strategic technologies	18
2.1 Advanced (Li-ion) battery technology	19
2.2 Fuel cells	24
2.3 Wind turbine generators	29
2.4 Traction motors (permanent magnets)	34
2.5 Photovoltaics	38
2.6 Robotics	43
2.7 Drones (Unmanned Aerial Vehicles or UAV)	47
2.8 3D printing (Additive manufacturing)	51
2.9 Digital technologies	55
3 Critical raw materials for strategic sectors	59
3.1 Renewable energy	60
3.2 E-mobility	65
3.3 Defence and aerospace	69
3.4 Sectorial competition and securing future raw materials supply	76
4 Conclusions and Recommendations	78
Bibliography	83
Glossary	85
Annexes	86
Annex 1 – Methodological notes	87
Annex 2 – Data tables	92

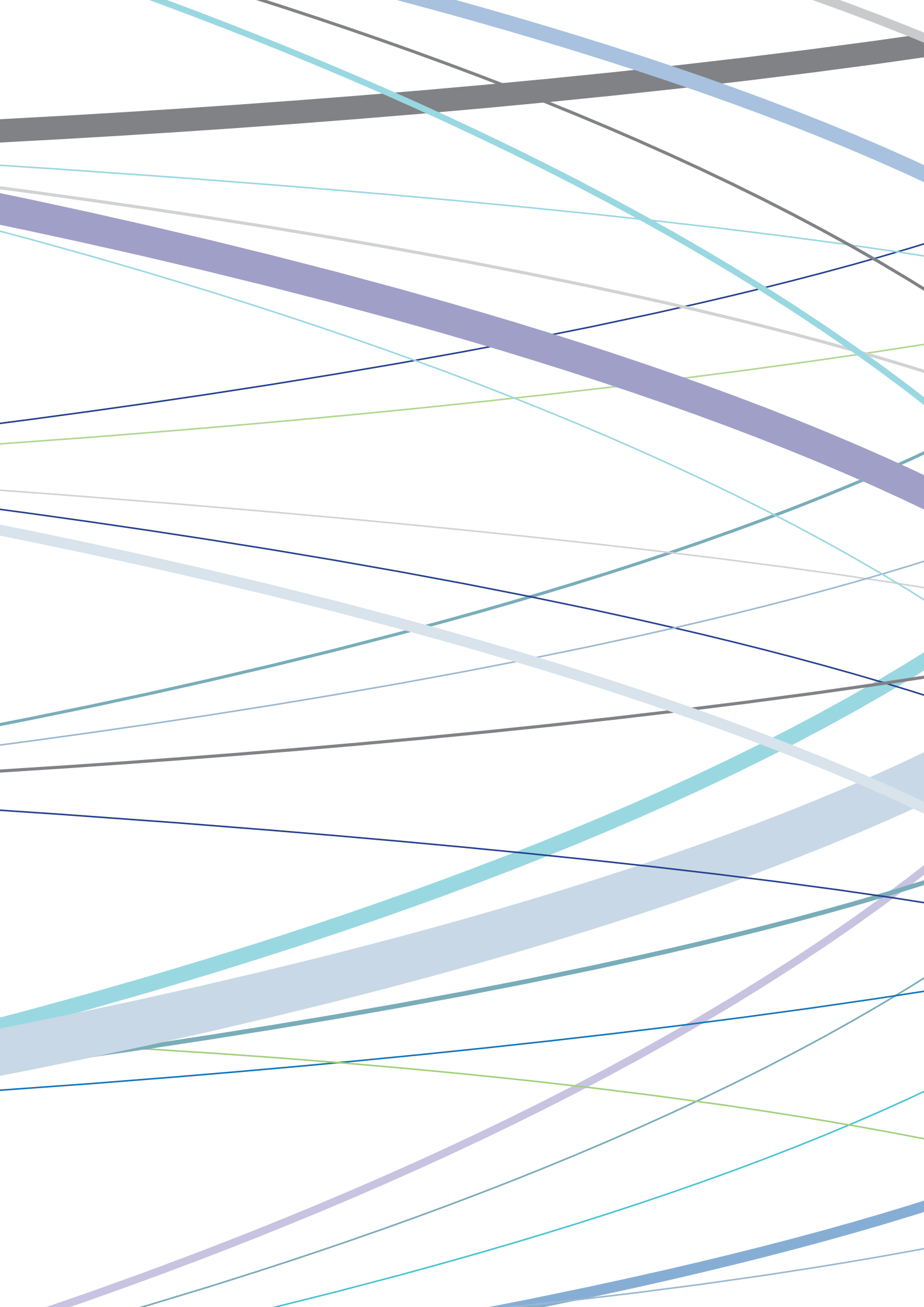



Executive Summary

Executive summary

This study looks at the supply chains of the nine technologies below used in the three strategic sectors renewable energy, e-mobility, defence and aerospace.

It also attempts to provide a first answer, based on available knowledge and models, to where future challenges lie and how competition for resources may evolve.



Li-ion battery technology is rapidly being deployed for both e-mobility and energy storage for intermittent electricity generation. The technology is increasingly relevant for defence applications;



Fuel cells (FCs) are an important energy conversion technology, which together with hydrogen as fuel, will offer a high potential for decarbonisation of the energy system and e-mobility in the future, although large-scale deployment has not yet taken place;



Wind energy is already one of the most cost-effective renewable energy technologies for climate-change mitigation and will remain a growing sector in the EU industrial base;



Electric traction motors are central components in e-vehicles. Permanent magnet motors containing rare earth elements are particularly efficient and attractive for current and future e-mobility applications.



Photovoltaic (PV) technology together with wind energy will lead in the transformation of the global electricity sector; PV panels are also relevant for space applications;



Robotics is an emerging technology with an increasing role in future manufacturing, including defence and aerospace, as well as energy technologies and automotive applications;



Drones (Unmanned aerial vehicles or UAV) are increasingly deployed for both civil and various defence applications;



3D Printing (3DP, Additive manufacturing or AM) will rapidly reshape traditional supply chains and replace conventional manufacturing, in particular in defence and aerospace. It will lead to a significant shift in the amount and types of raw materials and processed materials consumed;

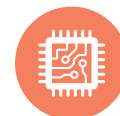

Digital technologies sustain the enormous digital sector enabling all technologies evaluated in this study.

Foresight

Using the mid-century models and scenarios of the EU's "Clean Planet for all" analysis, this study translates the shift to a climate-neutral economy through the deployment of renewable energy generation and e-mobility solutions into raw materials demand. The scenarios portray different levels of ambition from high to low deployment of these technologies to increased or lowered material efficiency, and as such are to be seen rather as a range than actual values.

The analysis in this study predates the Covid-19 crisis. Its impact on supply and demand, as well as on deployment of climate-neutral solutions are likely long-term. The current models do not take this development into account, but future analysis will have to account for these effects.

The current Commission places emphasis on foresight as a dimension of evidence-based policy-making and will continue this work.

The realisation of a climate-neutral, digital economy, and 'a stronger Europe' depends on available, affordable and responsibly sourced raw materials.

Many factors influence the supply of raw materials, and a high growth rate, as seen in Figure 1 does not directly convert to a future raw materials supply bottleneck. This depends on the overall supply–demand balance. High demand may raise prices, in turn making exploration, mining and refining projects as well as substitution and recycling commercially more attractive and viable. On the flip side, currently low prices for some materials may make investment in future capacity less attractive, considering that those investments require a high capital investment over a long period. The technical possibilities for upscaling extraction and refining capacities also play a role, as does the legal framework for mining activities. All factors combined determine supply 'flexibility' for the future.

Figure 1. Combined critical raw materials use in different technologies in the EU in 2030 and 2050



Batteries not only power electric vehicles but also store energy generated from variable sources such as sun and wind. They use the raw materials cobalt, lithium, graphite and nickel. Dysprosium, Neodymium and Praseodymium are rare earth elements (REEs) that are vital in building motors for electric vehicles and wind generators. (most relevant materials, see Annex 1 – Methodological notes and Annex 2 – Data tables for more information)

While figure 1 addresses the renewables and e-mobility sectors only, additional demand can be expected from other sectors, including defence and aerospace and digitalisation. For example, handheld devices use batteries, sensors and motors; data is stored on drives containing permanent magnets.

For the individual raw materials, figure 1 raises the following concerns for future supply:

- ▶ The multiplication factor for nickel in Figure 1 is in comparison to the total EU consumption of all nickel of any quality. However, in order to meet the rising demand for batteries, all of the additional demand and thus the newly commissioned capacity must shift to high purity nickel. This

structural change in the nickel market faces severe technological challenges, geological resource availability issues and trade barriers.

- ▶ For rare earths (REEs), China's dominance in the market renders the value chains extremely vulnerable. For the individual rare earths, dysprosium is at a higher supply risk due to the higher rate of demand growth and lower proportion in rare earth ores.
- ▶ For lithium, despite the highest growth factor, the short-term prospects are less of a concern compared to nickel and rare earths. However, in the medium-term, large investments are needed to avoid a significant market deficit beyond 2025.
- ▶ For cobalt, the concentration of supply in the Democratic Republic of the Congo will continuously remain a concern due to the country's large share in global extraction.
- ▶ For natural graphite, China is dominant in spherical graphite production. However, when prices become high, synthetic graphite can become a substitute.

Figure 2. Semi-quantitative representation of flows of raw materials and their current supply risks to the nine selected technologies and three sectors (based on 25 selected raw materials, see Annex 1 – Methodological notes)

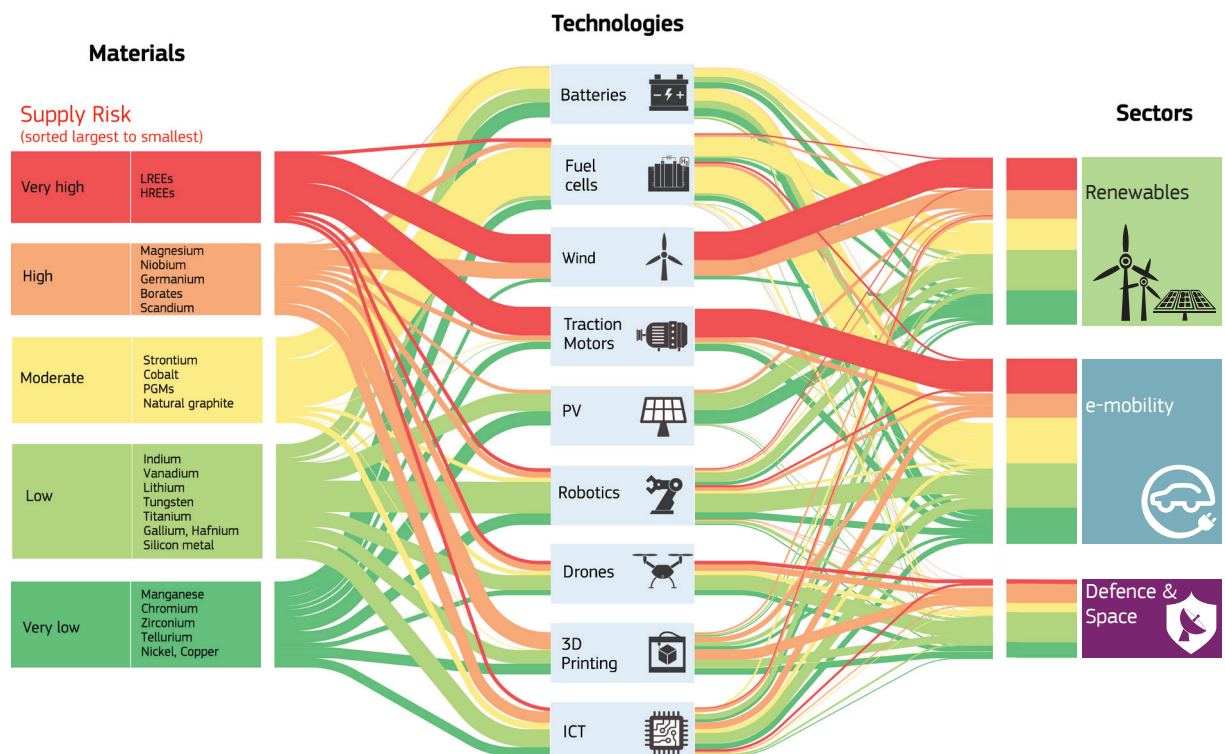

To arrive at any estimation on future demand and competition, raw materials, technologies and sectors have to be considered together, as several technologies and sectors are in competition for the same materials (see Figure 2):

- ▶ Wind energy and traction motors compete both for various REEs, as well as for borates; robotics and drones also use motors;
- ▶ Fuel cells and digital technologies require a large amount of platinum group metals (PGMs);
- ▶ The demand for battery raw materials cobalt, lithium, natural graphite and nickel originates both from e-mobility and from intermittent power generation from PV and wind generators and charging stations for electric vehicles;

- ▶ Digital technologies and PV are in competition for some materials like germanium, indium, gallium and silicon metal;
- ▶ Multiple sectors are competing for base metals like copper, aluminium, magnesium, nickel, iron ore and their alloying elements like tungsten, vanadium, manganese and chromium;
- ▶ All sectors are increasingly in need of more mature and stable markets for high-tech specific alloying elements. These materials used in e.g. super-alloys include niobium, scandium, hafnium and zirconium all with a very limited and, or a highly concentrated supply base.

Forecasts for the individual technologies and sectors are in the respective chapters.

Bottleneck Analysis

This study also identifies current supply risks in the subsequent stages of processed materials, components and assemblies. The results are displayed in Figure 3 for each

technology, except for ICT, which was not analysed in the same level of detail.



Bottlenecks for the EU are in the raw materials stages and the Li-ion cells production: China, together with Africa and Latin America, provides 74% of all battery raw materials. By itself China supplies 66% of finished Li-batteries. Currently, the EU provides less than 1% of Li-batteries.



The EU contribution is marginal in each step of the supply chain. However, a diversified set of technologies beside silicon-based panels results in a high number of suppliers for raw materials, with China representing half of the market. China's role becomes quasi-monopolistic at the components stage, resulting in a high supply risk. The EU only provides 1% of silicon-based PV assemblies



The fuel cell industry relies heavily on platinum-based catalysts, with platinum making up about half of the cost of a fuel cell stack. South Africa is by far the largest producer of platinum in the world, followed by Russia and Zimbabwe. Despite the high supply risk associated with all raw materials in fuel cells, the highest supply vulnerability regards the assembly step, where the USA plus Canada (48%) and Japan plus South Korea (51%) dominate production. Currently, the EU provides less than 1% of fuel cells.



44 raw materials are relevant to robotics, of which the EU produces only 2%. China is the major supplier of raw materials for robotics with 52%, followed by South Africa (15%) and Russia (9%). Similar potential bottlenecks could also occur in the supply of robotics components. On the other side, the EU is a major player of processed materials and assemblies of robotics with respectively 21% and 41% of global supply.



Within the supply chain for wind generators, the highest risks exist at the raw materials stage. The EU only provides 1% of the raw materials for wind energy. Major concerns exist about the supply of rare earths for the production of permanent magnets -- key components for the wind turbine generator -- for which China plays a quasi-monopolistic role. The EU plays a major role only in the assembly stage, where its share is above 50%.



The EU is highly dependent on external suppliers for raw materials and components as well as for UAV assemblies. Overall, China delivers more than one third of the raw materials, followed by South Africa (7 %) and Russia (6 %). More than 50 % of the raw materials come from numerous smaller supplier countries, providing good opportunities for supply diversification. China dominates civil drones production, and increasingly the professional drones sector, while the USA and Israel dominate military drone production.



Rare earths and borates contained in permanent magnets are crucial raw materials. The supply risks related to extraction and processing of rare earths are the main concern: China increasingly dominates the supply of these raw materials. Japan is a key player for the manufacturing of traction motors (60% of the market). The EU provides only 8% of traction motors:



3D Printing rapidly disrupts traditional supply chains and conventional manufacturing technologies. Besides the carrier materials aluminium, magnesium, nickel, titanium, the most relevant critical raw materials for metal-based 3DP are cobalt, hafnium, niobium, scandium, silicon metal, tungsten and vanadium. The raw materials stage is the main bottleneck: China provides 35% of the raw materials, while the EU only provides 9%. In processed materials however, the EU covers over half of the supply. For metal-based 3DP systems, the EU provides 34% of the global supply



Almost the entire periodic system of elements can be found in digital technologies, with a particular high share in consumption of elements like copper, gallium, germanium, gold, indium, PGMs, rare earths and tantalum. China (41%) and African countries (30%) are dominant suppliers. Europe is largely dependent on other countries (mainly from South-East Asia) for high-tech components and assemblies.

Figure 3. Identified supply risks for the EU and EU shares of production

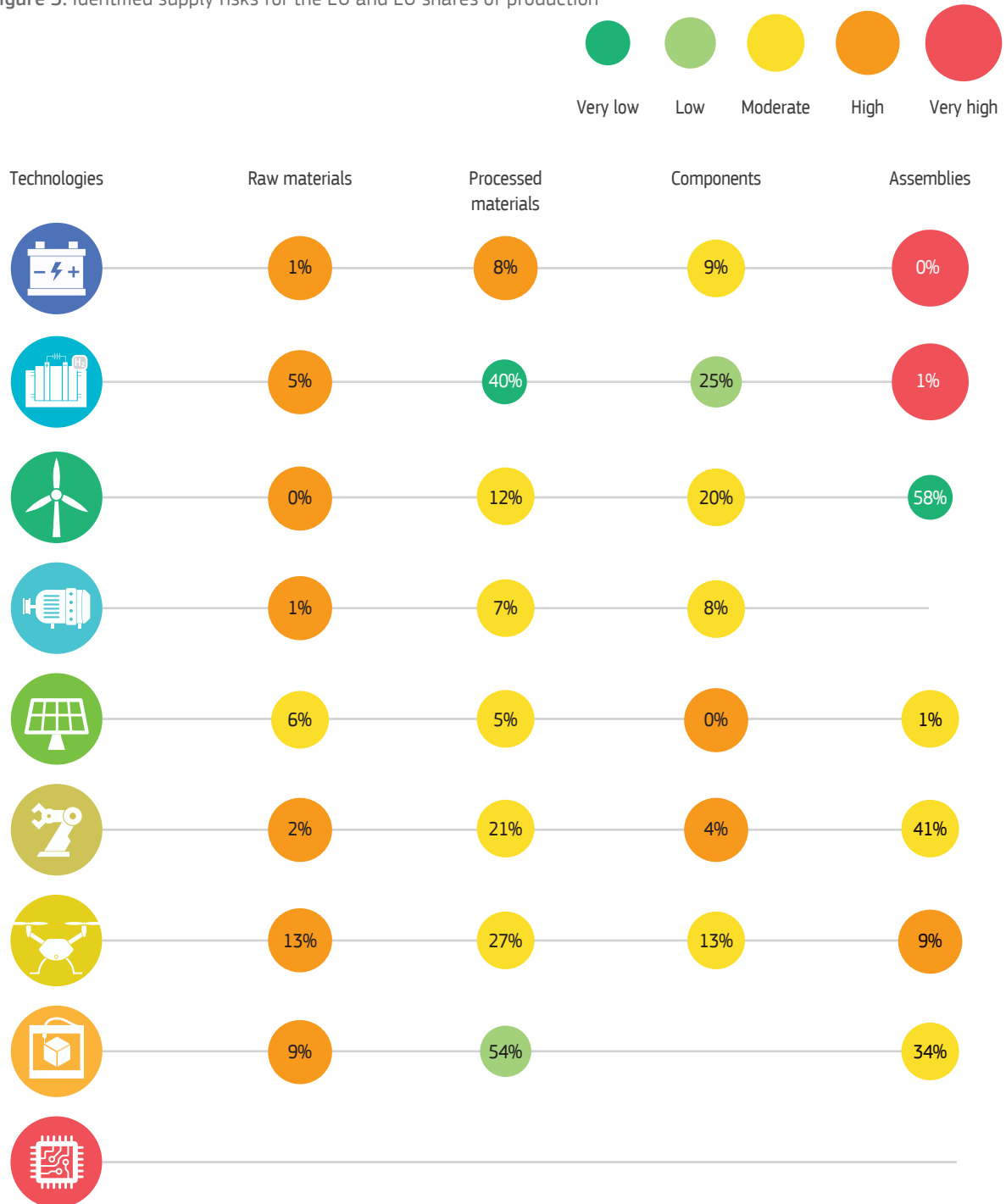



Recommendations

The EU needs to develop manufacturing opportunities to maintain a minimum of capabilities:

- ▶ For batteries, increasing EU raw materials production and processing and assembly capacities will require investments to reduce the dependency on the Asian market;
- ▶ Insufficient manufacturing capacity of solar cells appears to be the weakest link of the solar PV value chain in the EU. Therefore, domestic manufacturing opportunities need to be improved;
- ▶ For UAV, the EU faces a serious risk of missing the opportunity to catch up with these global leaders on this key technology, which is decisive to integrate comprehensive real-time geo-referenced intelligence;
- ▶ For digital technologies, technological sovereignty requires that the EU secures access to key raw materials and processed materials and redevelops manufacturing opportunities for key digital components and assemblies to the EU.

Maintaining leadership in value chains where Europe is currently strong, requires significant investment in R&D to match the pace of other countries and regions.

- ▶ For fuel cells, the main course of action is to improve reliability and reducing the cost through R&D with the goal to reduce the use of platinum from the fuel cell catalysts;
- ▶ For wind, a more secure supply of rare earths, possibly via recycling, could also contribute to preserving EU capability in magnet manufacturing;
- ▶ For robotics, securing access to raw materials and improving the capacity for components as well as providing a skilled work force will allow the EU to maintain a competitive position on the global market;
- ▶ Mastering the quality of 3DP materials in relation to specific 3DP technologies is key to maintaining EU competitiveness. Therefore, diversifying materials supply as well as R&D investments are vital to keep the current strong position.



1 Introduction

1 Introduction

1.1 Context and objectives

Raw materials are key enablers for all sectors of the EU economy. Some of the raw materials, in particular those assessed as critical raw materials (CRMs) (European Commission, 2020), are essential prerequisites for the development of strategic sectors such as renewable energy, electric mobility, defence and aerospace, and digital technologies.

Currently, EU industry is largely dependent on imports for many raw materials and in some cases is highly exposed to vulnerabilities along the supply chain. Following the global energy transition, the consumption of metallic raw materials necessary for the manufacture of wind turbines, PV panels, batteries and hydrogen production and storage, and other systems will drastically increase. The shift to e-mobility will require batteries, fuel cells and lightweight traction motors not only for cars but also for e-bikes, scooters and heavy duty transport. Defence and aerospace have always been strategically important, and remain at the forefront of technological developments; they deploy almost all of the technologies analysed in this report.

The study aims to provide scientific background on the potential supply risk of material resources for a set of nine value chains. It estimates, where data and models are available, the future demand for raw materials needed in selected strategic technologies, based on the long-term decarbonisation scenarios. The same analysis is carried out for the strategic sectors relying on these technologies. A systematic analysis of supply chain dependencies was conducted for Li-ion batteries, fuel cells (FC), wind turbines, electric traction motors, photovoltaics (PV), robotics, drones (UAV), 3D Printing (3DP, additive manufacturing or AM) and digital technologies. An overview of the technologies and sectors addressed in this study is visualised in Figure 4.

Each of these nine technologies are analysed in Chapter 2 in terms of (i) current supply bottlenecks along the value chain, (ii) future demand perspectives for raw materials and (iii) key observations and recommendations. Chapter 3 looks at the interdependency between various technologies and raw materials in the three sectors of renewable energy, e-mobility, and defence and aerospace.

Figure 4. Strategic technologies and sectors for the EU economy and their interlinkages



1.2 Approach

This study is conducted in collaboration with DG Internal Market, Industry, Entrepreneurship and SMEs, taking stock of available information from existing studies carried out by JRC and other organisations. It integrates new analysis on (critical) raw materials for strategic technologies and sectors. This study follows previous JRC reports including: assessment of potential bottlenecks along the materials supply chain for both low-carbon energy, transport technologies (JRC, 2016a) and defence sector (JRC, 2016b; JRC, 2019a) and CRMs and Circular Economy (JRC, 2017a) and the future materials demand for wind and solar PV technologies (JRC, 2020a).

For each technology, the current supply bottlenecks are assessed according to the approach used by the JRC in its recent study 'Materials dependencies for dual-use technologies relevant to Europe's defence sector' (JRC, 2019a). More specifically, four stages in the supply chain are analysed: raw materials, processed materials, components and assemblies.

A set of parameters as described in Annex 1 are used to qualify the potential bottlenecks in the supply chains of the technologies, which can result in a very low supply risk and very high supply risk (Figure 5).

Based on various long-term decarbonisation scenarios by 2050, material demand trends can be quantitatively assessed for Li-ion batteries, fuel cells, wind turbines, traction

motors and solar (PV). For robotics, drones (unmanned aerial vehicles), 3D printing (additive manufacturing) and digital technologies, as well as for the defence and aerospace sector, the quantitative assessment presents partial information on market uptake, where available.

The materials demand calculations consider four factors including installed capacity, plant lifetime, sub-technology market share and materials intensity. Combinations of high and low contributions of these four factors allow the development of a quantitative assessment. This is based on three demand scenarios, defined as low-demand scenario (LDS), medium-demand scenario (MDS) and high-demand scenario (HDS). MDS is characterised by average assumptions on the sensitivity factors and depicts the most likely scenario in the light of current technology and market trends. LDS and HDS are developed through the combination of the lowest and highest values of the sensitivity factors, respectively. For example, LDS considers high material efficiency and low ambition of GHG reduction, resulting in low deployment of technologies and consequently low demand for raw materials. HDS consider low material efficiency and high ambition of GHG reduction resulting in high deployment of technologies and consequently high demand for raw materials.

More information about the calculation of supply bottlenecks and demand scenarios is presented in Annex 1 – Methodological notes.

Figure 5. Supply risk indication

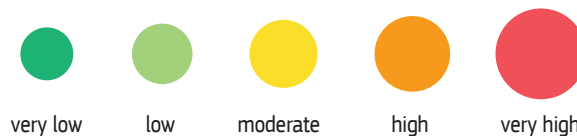

1.3 Scope and limitations

This foresight study is based on available data for the selected nine strategic technologies and three sectors. It highlights knowledge gaps and provides recommendations on how to develop more in-depth and quantitative information for the future. The selection of technologies is non-exhaustive and takes into account anticipated growth rates leading to a notable increase in consumption of raw materials (e.g. wind and solar PV technologies), their relevance for strategic sectors such as defence or aerospace (e.g. 3D printing and drones) or importance across new emerging sectors (e.g. FC, robotics, digital technologies). The geographical and temporal scope of the study is on current and 2030 versus 2050 EU consumption. This study faces some general limitations:

- ▶ The analysis of bottlenecks for each technology and determining of shares from countries is based on key market research reports and publicly available information. As far as possible, company headquarters are used instead of production locations. However, this distinction is not always clear since most market reports are not designed to reflect this. Some technologies like 3DP are undergoing substantial change in a short period, which may outdate the information relatively quickly.

- ▶ Although the work includes a considerable number of technologies (9) and sectors (3), many relevant others (e.g. lasers, semi-conductors, satellites) have not been taken into account due to limited information available on the types of materials and their use especially in the space applications.

- ▶ Although the demand scenarios used for the material amount calculations cover a wide range of policy-relevant carbon mitigation futures, they inevitably show some misalignments in the modelling assumptions. Recent COVID-19 effects on supply and demand are not factored in.

- ▶ There are several options for the baseline for comparison with current demand for raw materials. In this report we chose to use 22% of global demand for each material, reflecting the EU share of global GDP as the most consistent approach for all materials.

See Annex 1 – Methodological notes, for more elaborate limitations and assumptions.



Figure 6. Critical and non-critical raw materials use in different technologies (selected top-25 materials)

Supply Risk	Material									
●	LREEs		●	●	●		●	●		●
●	HREEs		●	●	●		●	●		
●	Magnesium		●				●	●	●	●
●	Niobium	●		●				●	●	
●	Germanium					●		●		●
●	Borates		●	●	●	●	●	●	●	●
●	Scandium							●	●	
●	Strontium		●				●	●		
●	Cobalt	●	●	●			●	●	●	●
●	PGMs		●				●	●		●
●	Natural graphite	●	●				●	●		●
●	Indium					●	●	●		
●	Vanadium		●				●	●	●	●
●	Lithium	●	●				●	●		
●	Tungsten						●	●	●	
●	Titanium	●	●				●	●	●	●
●	Gallium					●	●	●		●
●	Silicon metal	●	●		●	●	●	●	●	●
●	Hafnium							●	●	
●	Manganese	●	●	●			●	●	●	●
●	Chromium		●	●			●	●	●	●
●	Zirconium		●				●	●	●	●
●	Silver		●			●	●	●		●
●	Tellurium					●	●	●		●
●	Nickel	●	●			●	●	●	●	
●	Copper	●	●	●	●	●	●	●	●	●

Materials in red are critical raw materials. Light rare earth elements (LREEs), heavy rare earth elements (HREEs) and platinum group metals (PGMs) are groups of multiple raw materials

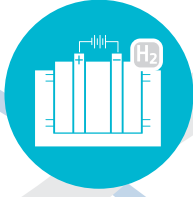
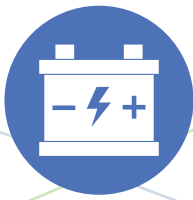

2 Critical raw materials in strategic technologies

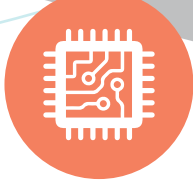



2.1 Advanced (Li-ion) battery technology

Li-ion battery technology is becoming a mature technology employed a wide range of applications. It offers improved power and energy performance compared to the currently used lead–acid batteries. While Li-ion batteries are crucial for defence applications, their development and future uptake are primarily driven by the civilian demand for portable electronic devices, stationary energy storage and electric vehicles (EVs). Lithium metal oxide batteries use various different metals, such as nickel, cobalt, aluminium and manganese. There are tens of individual materials possibly present in the cell anodes, cathodes, electrolytes and separators. Figure 7 lists the most common raw materials used (and forecasted) in batteries and their functionality.

Various technical and economic trends affect the composition of Li-ion batteries. Recent battery research focuses on new

anodes (including lithium metal, silicon metal, titanium and niobium), coating materials (including niobium and titanium), new cathodes (including niobium (CBMM, 2018)) and closer packing (less electrolyte, thinner separators and thinner current collectors). The main aim is to increase the specific energy to lower weight and volume while maintaining power capabilities to reduce charging times, depending on the applications. For cost-saving reasons, changing the cathode chemistry mix decreases the overall proportion of cobalt in favour of other materials such as nickel and/or aluminium. As a result, this potentially reduces safety and durability which becomes increasingly important. Hence, research focuses on fire-retarding electrolyte additives, ionic liquid electrolytes, the use of ceramic separators, ceramic coating of electrodes and solid-state batteries.

Figure 7. Raw materials used in batteries. See the Glossary for the acronyms used.

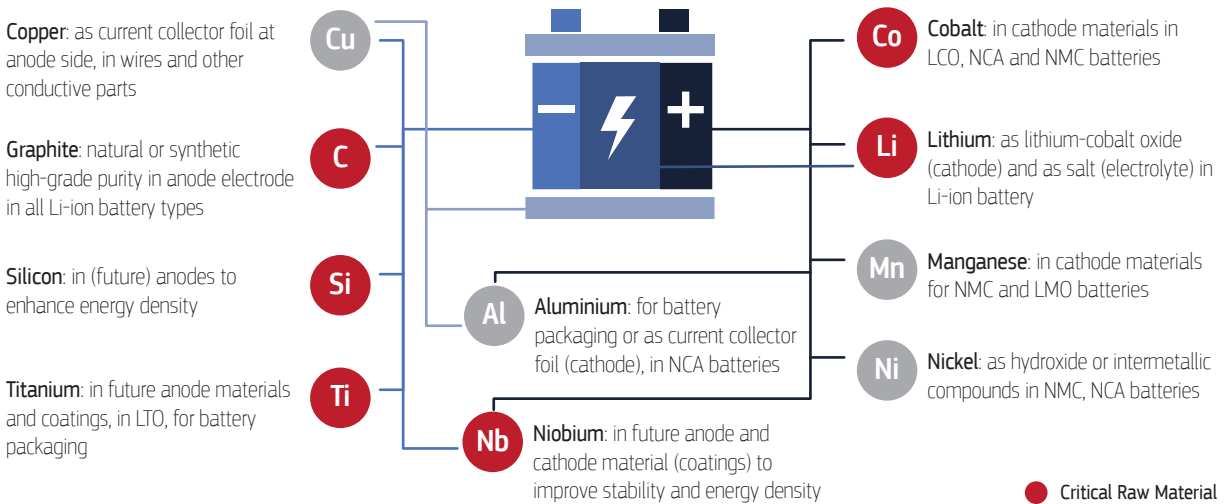

2.1.1 Current supply bottlenecks along the value chain

Of all materials currently used in battery manufacturing, cobalt, natural graphite, and lithium are critical in the 2020 list of CRMs. Research is looking at silicon metal, titanium and niobium to improve energy density, durability, and safety in future Li-ion battery types. Figure 8 shows the key players in the Li-ion cell supply chain.

The EU produces only 1% of all battery raw materials overall. Individual materials also warrant a closer look: 54% of global cobalt mine production originated from the Democratic Republic of the Congo, followed by China (8%), Canada (6%), New Caledonia (5%) and Australia (4%). Refined cobalt production comes from China (46%), Finland (13%), Canada and Belgium (both 6%).

Around 90% of global lithium mine output is produced in Chile (40%), Australia (29%) and Argentina (16%), mostly from brine and spodumene sources. China (45%) hosts the majority of the world's lithium hard-rock minerals refining

facilities. Chile (32%) and Argentina (20%) dominate refined lithium capacity from brine operations (EC, 2019). Despite the recent fears of shortages and price spikes, the supply of lithium is expected not to be a major issue for the battery supply chain in the short or medium term. Nevertheless, according to (Roskill, 2018) an increase from current low prices is deemed necessary to support the development of new production capacity for the long-term.

Not all nickel in the global supply chain is suited for Li-ion battery production. High-grade nickel products are dependent on the production of nickel sulphate, which is a principal ingredient in NMC (Nickel Manganese Cobalt oxide) and NCA (Nickel Cobalt Aluminium oxide) batteries. Due to past price collapses, the investments in refining capacity for nickel have been low, threatening the requested supply of nickel class I (with a purity above 99.8%) in particular (EC, 2019).

Figure 8. Li-ion batteries: an overview of supply risks, bottlenecks and key players along the supply chain. (See the Glossary for the acronyms used)

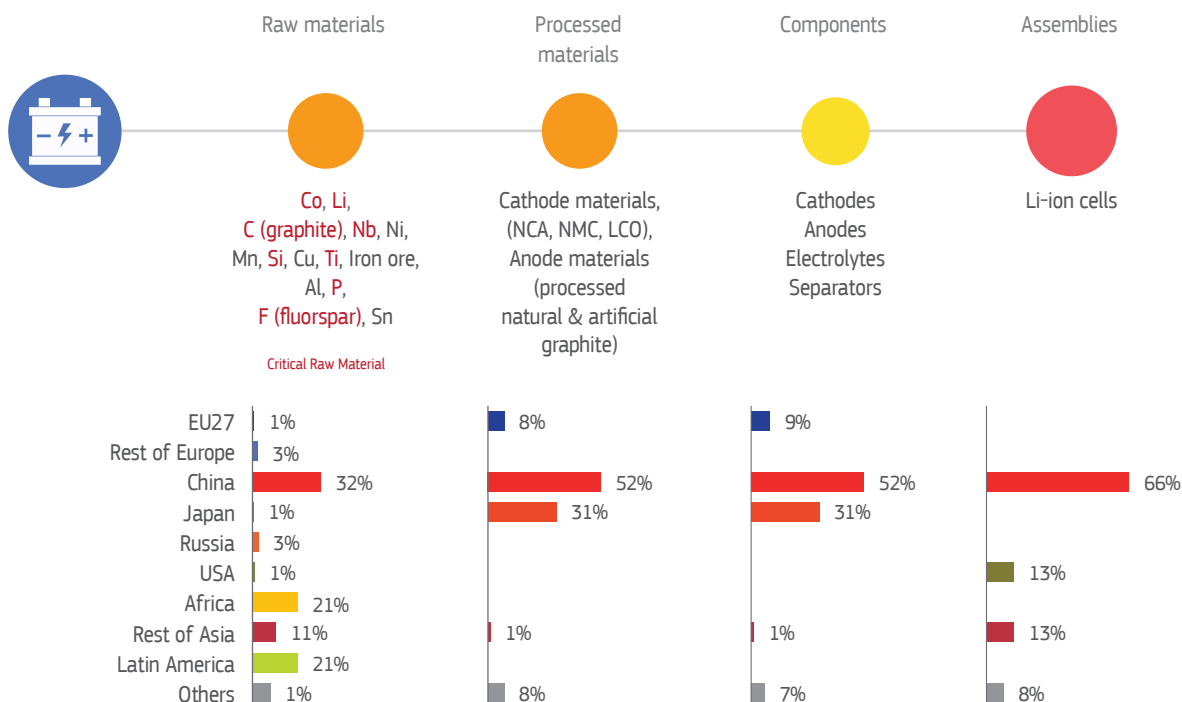

For natural graphite there are existing requirements related to flake size distributions and carbon content. These are typically achieved via additional refining steps, where China holds the majority of the capacity (Roskill, 2018) for the production of spherical graphite. How much of global supply is suitable for the production of spherical graphite requires further analysis.

China is the major supplier of anode materials, as well as NMC (Nickel Manganese Cobalt oxide) and LCO (Lithium Cobaltoxide) processed materials, while Japan is the key supplier of NCA cathode material. The EU is fully dependent on anode materials and NCA cathode material supply, and delivers around 18% of NMC materials and 15% of LCO materials.

A critical aspect for the EU is that these volumes are not enough to satisfy the European demand for Li-ion batteries. Asia, represented by China, Japan and South Korea, delivers 86% of the processed materials and components for Li-ion batteries globally. The EU27, with 8%, has a relatively small share of the supply. Other countries deliver only 8%, which gives very little margin for supply diversification.

The EU is fully dependent on imports of battery cells, exposing the industry to supply uncertainties and potential high costs. China is the major player in manufacturing Li-ion cells – 66% of global cell production. The EU has very marginal production (0.2% of Li-ion cells). Other suppliers provide around 8% of the global supply, hence the current margin for supply diversification is limited. The EU however is significantly investing in the battery value chain. The EU capacity expected to be available in 2021-2023 will increase to 40 GWh, from 3 GWh currently in place. Several of these production facilities are Asian investments. These European capacities compare to a current global capacity of 150 GWh identified now (JRC, 2018a). Simultaneously, a large step-up in production capacity of Li-ion cells will be realised by Chinese companies, which will guarantee the dominance of China in the battery market. Original equipment manufacturers, cell manufacturers and suppliers will likely compete globally with each other to secure their battery supply chains and to secure access to the five essential battery raw materials – lithium, cobalt, nickel, graphite and manganese.

2.1.2 2030/2050 perspectives of raw materials demand

Batteries for e-mobility

Three scenarios for the fleet of EVs containing batteries in the EU are considered (see Figure 9). These fleet scenarios are derived on the LDS, MDS and HDS scenarios as defined in Section 1.2 (see the Glossary for all abbreviations). The LDS scenario considers a reasonably quick uptake of EVs in general, with plug-in hybrid vehicles (PHEV) keeping a significant

share of the fleet. In the MDS scenario, there is quicker uptake of full EVs and PHEV are considered as transition technologies with a significant share of the fleet until 2030 and a rapid decrease afterwards. The HDS scenario is characterised by an extremely quick uptake of full EVs, with PHEV uptake starting its decline already from 2024.



From the fleet figures, the number of batteries entering the EU market is derived and the subsequent EU annual demand of various raw materials is assessed. See Annex 1 of the methodological notes and assumptions. Forecasted EU an-

nual consumption of materials in batteries of EVs in 2030 and 2050, along with the current demand, is presented in Figure 10.

Figure 9. EU fleet of electric vehicles containing batteries according to the three explored scenarios

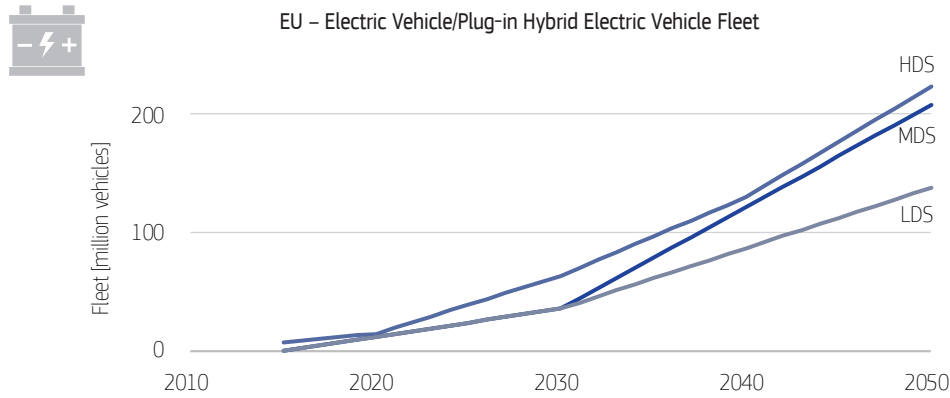
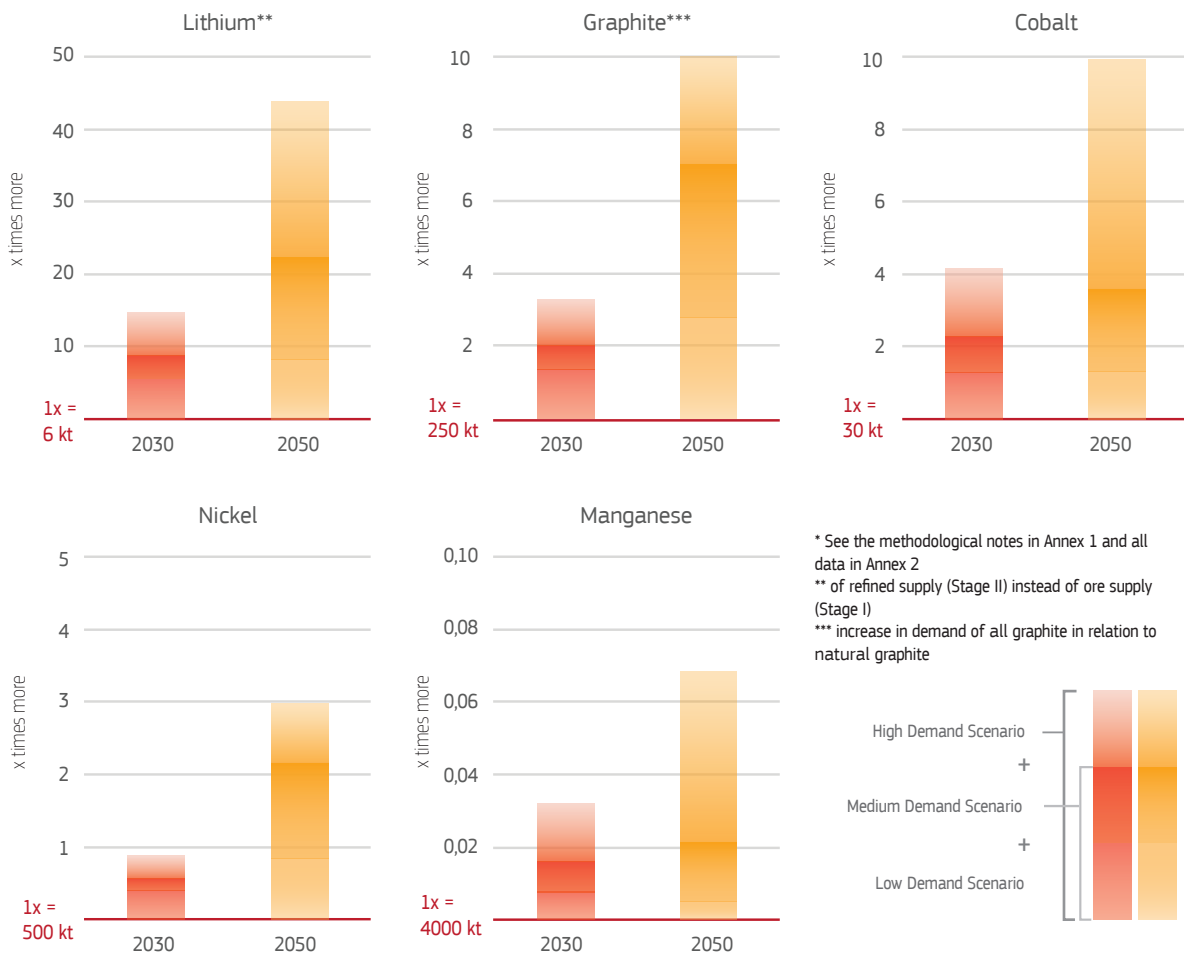

Figure 10. EU annual material demand for batteries in EVs in 2030 and 2050



Additional material consumption for batteries in **e-mobility only** in 2030/2050 compared to current EU consumption* of the material in **all applications**



Batteries for energy storage systems (ESS)

Li-ion batteries are already widely deployed technologies for Energy Storage System (ESS) and they will continue to develop. The storage capacity is derived for the LDS, MDS and HDS scenarios as defined in Section 1.2 (see the Glossary for all abbreviations). More methodological notes are available in

Annex 1. In Figure 11 for the HDS and in the MDS scenarios important capacities of hydrogen storage will be deployed, differently from the LDS scenario. For this reason, in 2050, the Li-ion battery storage capacity in the MDS is assumed lower than the capacity in the LDS.

Figure 11. EU battery storage capacity according to the three explored scenarios

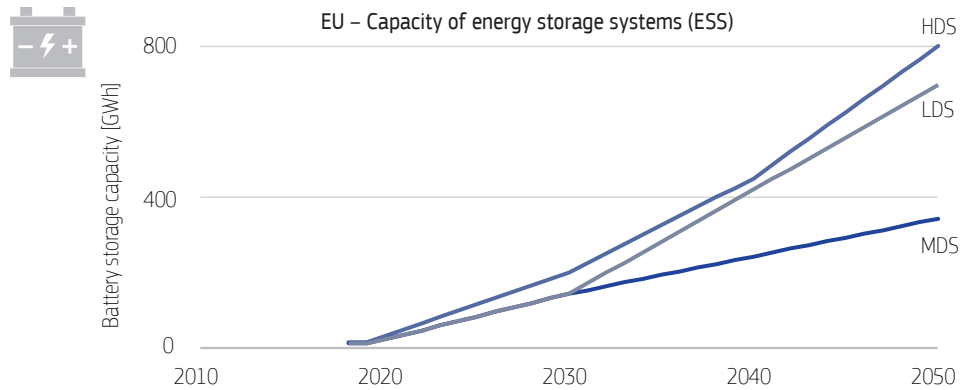

Figure 12. EU annual material demand for ESS batteries in 2030 and 2050

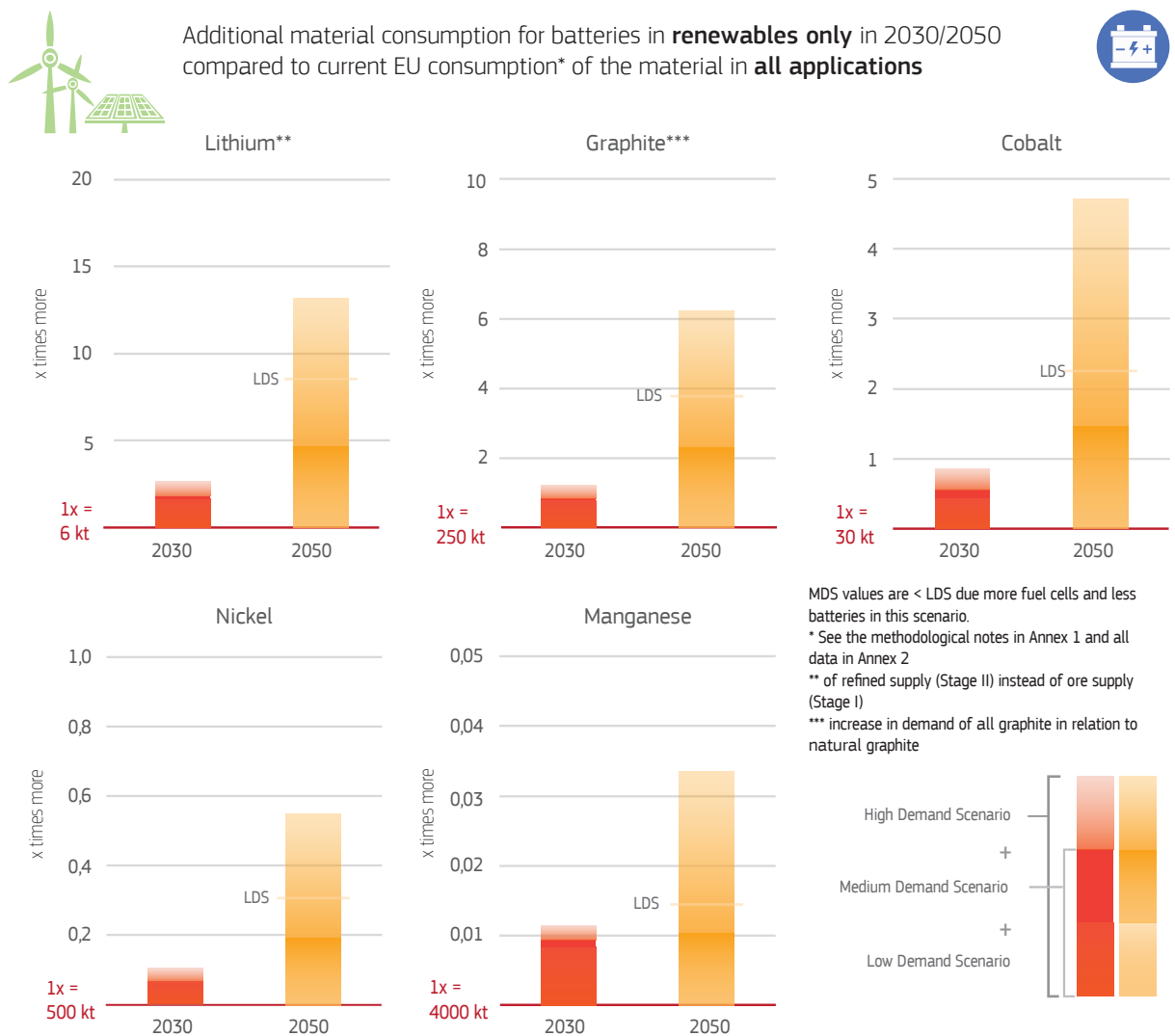



Figure 12 presents the forecast of EU annual consumption of materials in ESS batteries in 2030 and 2050. Lower quantities of battery raw materials are required for the MDS scenario compared to LDS due to the large share of FCs in energy storage, as described above.

Section 3.4 discusses the combined results for raw materials for batteries for e-mobility and energy storage together.

2.1.3 Key observations and recommendations

Li-ion batteries offer improved power and energy performance compared to the currently used lead–acid batteries. They are emerging as an important technology across a wide range of civil and defence applications. As a result of the increasing introduction of EVs (EV), mobile electrical appliances (3C) and stationary decentralised energy storage systems (ESS), demand for lithium-ion batteries is expected to skyrocket yearly (> 30%) for the next 10 years.

The last step of the supply chain, Li-ion cells production, is carrying a very high supply risk for the EU. A high risk is identified for the supply of raw and processed materials, while a medium level of risk is anticipated for the supply of components.

Various estimates suggest that the civilian industry in the EU requires up to 30% of battery cells produced worldwide. This means that cell production capacity needs to be built up in the EU to reduce dependency on the Asian market. Analysis of the civil market shows that the necessary quantities in the EU cannot be serviced in the coming years even by combining the capacities of Asian and European cell manufacturers.

The Strategic Action Plan on Batteries lies down a comprehensive strategy to enhance the EU battery value chain stages. Nevertheless, the EU position could be further strengthened by:

- ▶ *Diversifying the materials supply*: Secure trade agreements with third countries and employ economic diplomacy for cobalt, lithium, natural graphite and nickel class-I to reduce supply risks.
- ▶ *Promoting R&D investments, development skills and competences*: Further analysis is recommended on the (economic) mechanisms enabling improved social and environmental standards, without causing competitive disadvantage for European companies involved compared to their non-European counterparts. Specific investments in R&D and in particular in battery-related materials sciences, geology and metallurgical studies are recommended.
- ▶ *Improving manufacturing opportunities in the EU*: Increase mining, extraction and refining in the EU for key raw materials and processed materials. It is important to create an attractive investment climate as well as specific eco-systems for batteries manufacturing where a range of companies with different expertise in the value chain align themselves. Simultaneously, attracting foreign investments of electronics, automobile and battery manufacturing companies can directly support higher environmental and social standards compared to activities elsewhere in the world.
- ▶ *Fostering international collaboration and standardisation activities*: Ecodesign requirements are essential for fostering higher levels of reuse, remanufacturing and recycling, including the increased use of recycled content in new products to lower both environmental and raw material footprints
- ▶ *Recycling and reuse, substitution*: Boosting recycling activities in the EU is a no-regret solution that allows key materials such as cobalt, lithium, manganese and nickel to be recovered and reused in the production of new batteries.

2.2 Fuel cells

In the medium to long-term, fuel cells (FCs) together with hydrogen fuel supply will offer an attractive potential clean energy solution. FCs can contribute significantly to sustainable and secure energy supply systems. The technology connects two basic future energy carriers: electricity and hydrogen.

FCs are electrochemical devices that convert fuel such as hydrogen directly to electricity without combustion. Hydrogen reacts with oxygen in the FCs to form water and releases electrons producing an electric current through an external circuit. Polymer Electrolyte Membrane Fuel Cell (PEM FC) technology is the most popular type of FC. FCs are highly efficient in terms of energy conversion, reduce air pollution and are capable of running on fuels produced from renewable resources.

Several FC types are today available (Figure 13), capable of operating under different conditions depending on the type of fuel, operation temperature and the type of electrolyte such as:

- ▶ Polymer Electrolyte Membrane FC (PEM FC)
- ▶ Phosphoric Acid F (PA FC)
- ▶ Alkaline FC (A FC)
- ▶ Molten Carbonate FC (MC FC)
- ▶ Solid Oxide FC (SO FC)
- ▶ Direct-Methanol FC (DM FC)

Figure 13. Overview of various fuel cell types and operation conditions.

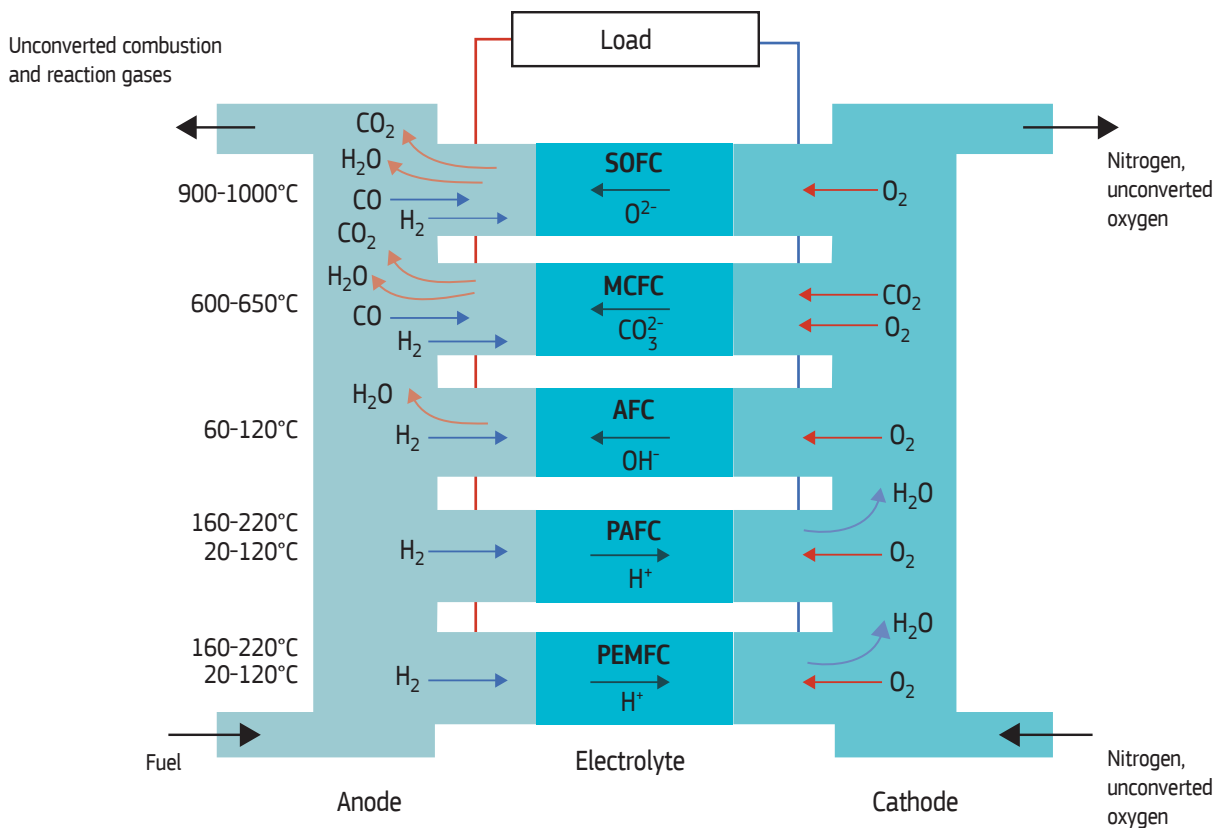

Source: adapted from Ginley & Cahen, 2012

PEM FC has a high power density and operates at relatively low temperatures compared to other FC types, making it ideal for the automotive sector, telecommunications, forklifts, primary systems, data centres and backup power systems.

Although FC technology has come a long way in technology maturity, large-scale deployment in domestic and industrial segments has not yet taken place. Today, the FCs are used in three main areas: stationary power generation (ca. 67% market share), transportation (ca. 32%), and portable power

generation (<1%). The FCs market for the automotive industry is expected to grow significantly in the future. An increasing demand for FCs is also expected in material-handling vehicles, light-duty vehicles, buses, and the aerospace sector.

FCs use catalysts, commonly made from platinum or platinum-group metals (PGMs), for the fuel to power conversion. Current research focuses on reducing or eliminating these expensive metals from catalysts, and on increased activity and durability. A significant reduction has been achieved in

the recent years. Due to active dematerialisation efforts, the PGM intensities in PEM FCs fell by 80% since 2005 (Leader, Gaustad, and Babbitt, 2019). According to the European Commission's FC and hydrogen joint undertaking (FCH JU), the amount of platinum in the next generation of FC vehicles will reach similar levels to that used in the catalytic converters of diesel vehicles, which corresponds to 3-7 grams (Reuters Business News, 2018). This could significantly enable large-scale commercialisation of FC-powered vehicles.

Most FCs have a standard design in which two electrodes are

separated by an ion-conducting electrolyte. The heart of a PEM FC is the membrane electrode assembly (MEA), which includes five basic components: membrane, anode catalyst layer, cathode catalyst layer and two gas diffusion layers (GDLs) one for each electrode.

On overview of the raw materials adopted in FCs is shown in Figure 14. The materials and components related to the hydrogen production and storage were also considered in this analysis.

Figure 14. Relevant raw materials used in in fuel cells (FCs)

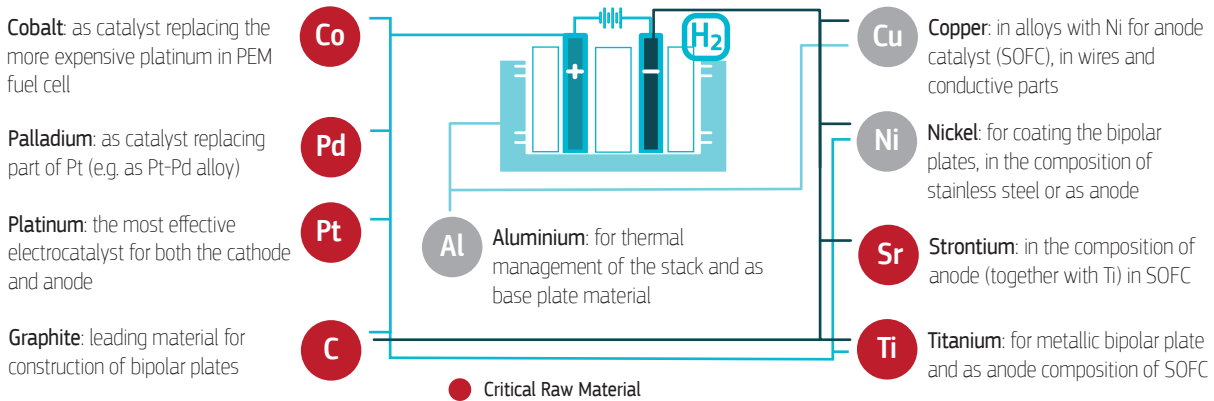

2.2.1 Current supply bottlenecks along the value chain

Around 30 raw materials are needed for producing FCs and hydrogen storage technologies. Of these materials, 13 materials namely cobalt, magnesium, REEs, platinum, palladium, borates, silicon metal, rhodium, ruthenium, graphite, lithium, titanium and vanadium are deemed critical for the EU economy according to the 2020 CRM list. Materials and components along the supply chain are presented in Figure 15.

The unique chemical and physical properties make PGMs excellent catalysts for the automotive industry. Today, platinum demand for FC applications is insignificant compared with other end-use applications. However, a FC vehicle needs 10 times more than the PGM loading of an average gasoline or diesel vehicle (Hao et al., 2019).

The high price of platinum is one of the major challenges faced by the FC producers; platinum represents about 50% of the cost of a FC stack. Hence, researchers are continuously trying to reduce the need for platinum in FCs. The supply of raw materials required in FC technology is diversified with more than half of the materials coming from a variety of suppliers, each with a small supply share of less than 7%. China, with more than 20% share, is the major supplier of raw materials, followed by South Africa and Russia. Platinum is produced mainly in South Africa (71% of global produc-

tion), followed by Russia (16%) and Zimbabwe (6%). The other PGMs, namely palladium, rhodium and ruthenium are also supplied predominantly by three key suppliers: Russia, South Africa and Zimbabwe.

With regard to the next step in the supply chain, 12 processed materials are identified as the most relevant processed materials for FC and hydrogen storage/production technologies, namely porous carbon, yttria stabilised zirconia, polymers (e.g. perfluorosulphonic acid - PFSA), carbon fibre composites (CFC), stainless steel, graphene, scrap and flake mica, boron nitride powder, nano materials & carbon nano tubes, carbon cloth/paper, polyamide ultramid and metal hydrides. For the electrodes, several types of carbon or carbon-based materials have been developed, including mesoporous carbon and carbon nanomaterials. Around 40% of processed materials and 25% of FC components are supplied by European companies.

Carbon fibre paper and carbon fabric (cloth) are commonly used as gas diffusion layers (GDLs) that are key components in various types of FC, including PEM, DM FC and PA FC stacks. Bipolar plates are multi-functional components within the PEM FC stack. The materials used for bi-polar plates include graphite and stainless steel. However, stainless steel for bi-

polar plates has to be coated to increase functionality and increase lifetime. Typical examples of coating materials with excellent properties are gold and other noble metals. Due to the high cost of noble metals, it is desired to find alternative coating materials.

The major producers of FCs are Asia (mainly Japan and South Korea) and North America (Canada and USA). The last step of the FC supply chain is the assembly of cell components into a stack and its integration in the final system. The stack design and cell assembly are very important parameters that can influence the performance of FCs and distribution of reactants in the cell stack. The cell assembly will also affect the contact behaviour of the bipolar plates with the mem-

brane electrode assembly (MEA). Manufacturers must align precisely the repeating components (e.g. MEAs, bipolar plates and seals) and non-repeating components (e.g. end plates, tie rods, compression load system, and external manifolds) to maintain stack durability and performance.

The key players involved in the FC supply chain are displayed in Figure 15. The country shares take into account also the materials used in hydrogen production (Step 1) and hydrogen storage (Steps 1, 2 and 3). The bottleneck assessment shows a potential very high supply risk for the assembled FCs. High risk of supply issues is estimated for the first step of the supply chain - raw materials. No supply issues are expected for the other two supply chain steps.

Figure 15. FCs and Hydrogen technologies: an overview of supply risks, bottlenecks and key players along the supply chain.

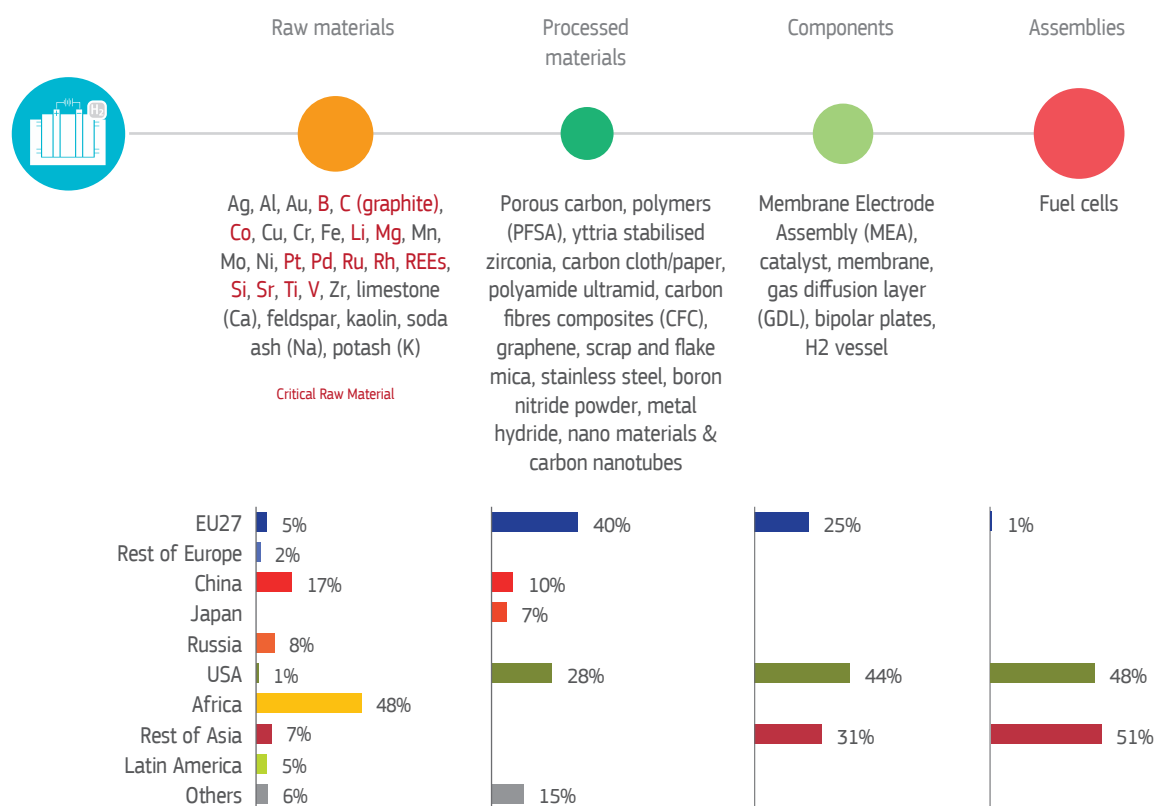



2.2.2 2030/2050 perspectives of raw materials demand

FC are used in both the automotive sector and for energy storage, therefore the raw materials demand in both technologies is estimated. Among the CRMs embedded in FCs, the current analysis focuses only on the platinum content, aligned with the available literature and the above considerations, e.g. Månberger and Stenqvist (2018) and Sun et al. (2011). The forecasts of the fleets of FC vehicles for the three scenarios are presented in Figure 16.

The scenarios for the fleet of vehicles are the ones described above, with FC vehicles taking a particularly significant share in the fleet for the HDS scenario. See Annex 1 – Methodological notes for a further explanation.

FC can also be deployed for stationary ESS. Figure 17 presents the 2030 and 2050 EU demand for platinum contained in FCEVs plus FC ESS, expressed in relative terms in respect to current EU supply. The estimated demand of platinum for both FCEVs and FCs in ESSs is presented in Figure 17. From the individual values provided in Annex 2 - Data tables, it is observed that the amount of platinum for FC ESS is much higher than the demand for FCEV. The data tables in Annex 2 provide the individual amounts in both applications.

Figure 16. EU fleet of fuel cell electric vehicles according to the three explored scenarios

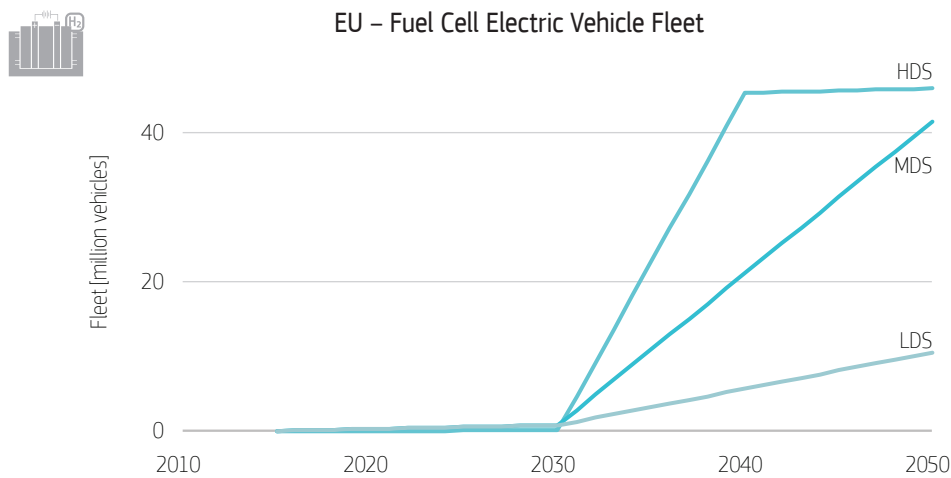
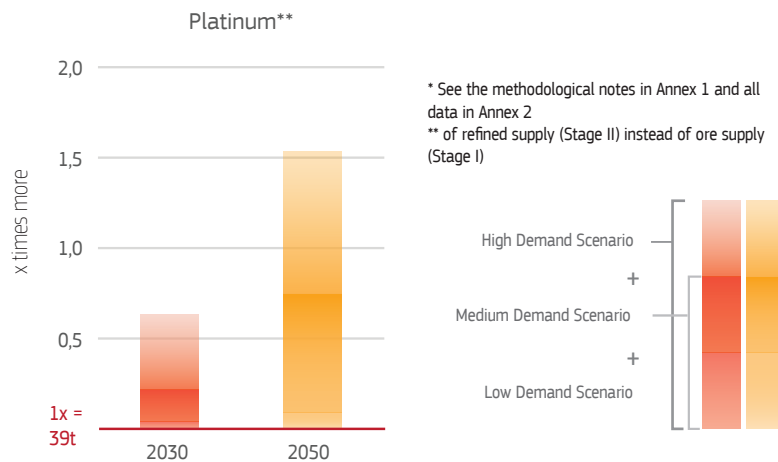

Figure 17. EU annual material demand for platinum in FCs in 2030 and 2050



Additional material consumption for fuel cells in **e-mobility and renewables** only in 2030/2050 compared to current EU consumption* of the material in **all applications**



2.2.3 Key observations and recommendations

Although FC development and deployment has grown during the last 10 years, it is still uncertain when this will reach full mass commercialisation. FC manufacturers remain largely dependent on public funding in order to support deployment activities of large-scale stationary FCs, whether through technology push or market pull measures. The main barriers at this stage are the reliability (availability and lifetime) and cost of the FCs.

Several key opportunities for policy actions are identified:

- ▶ *Diversifying the materials supply:* As for Li-ion batteries, more than half of the raw materials for FCs are procured by numerous smaller supplier countries.
- ▶ *Improve manufacturing opportunities in the EU:* Steam reforming of natural gas is the currently preferred option for hydrogen production and can either take place on a very large scale at source, or even locally at the point of use by small reformers integrated with the FC.
- ▶ *Recycling and reuse, substitution:* Though recycling of FCs and hydrogen technologies can be regulated by legislation that addresses aspects such as design, material selection and end-of-life, the recycling of FCs is a new business for recyclers and a potential topic for research. Finding an alternative for platinum will avoid the immediate problem of price and availability. Despite many efforts to substitute platinum with non-precious metal catalysts there has been little success in finding effective alternatives with similar level of activity. An alternative solution is to replace platinum with other precious metals such as palladium or ruthenium, but their abundance is also finite.
- ▶ *Promote R&D, develop skills and competences:* Promoting research in FC development is feasible and can offer attractive opportunities for the EU. To this end, the most important partner would be the FCH JU. Although the design of the next European research framework programme is still ongoing, it is expected that the concept of a private-public partnership will remain basically the same. The FCH JU is also developing training and educational tools to increase confidence and technical trust in the technologies and to develop a skilled European workforce capable of operating FC systems.
- ▶ *Foster international collaboration and standardisation activities:* FCs and hydrogen technologies profit from an international approach to the development of the required infrastructure, of a global market for great quantities of hydrogen and of global regulations enabling their safe adoption in all parts of the world. Pre-normative research results are also shared internationally in the framework of a global standardisation and regulatory effort. The existence of performance, safety and permitting standards and technical regulations is considered one of the enablers for a successful development and deployment of new technologies. The development of industrial standards enabling component compatibility and inter-operability can contribute to reducing costs and increasing the availability of components.



2.3 Wind turbine generators

Wind energy is one of the most cost-effective technologies for climate-change mitigation and is a growing sector in the EU industrial base. Further penetration of wind technology in the EU and global markets is dependent on its techno-economic characteristics alongside regulatory frameworks and the effectiveness of energy policies. It will also be influenced by the stability of material supply and evolution of material prices.

Today, a mix of wind turbine types is used to meet the various specific onshore and offshore site conditions, for example:

- ▶ Direct drive EESG (electrically excited synchronous generator);
- ▶ Direct drive PMSG (permanent magnet synchronous generator);
- ▶ Gear-box PMSG (permanent magnet synchronous generator);
- ▶ Gear-box DFIG (double-fed induction generator);
- ▶ Gear-box SCIG (squirrel cage induction generator).

All these technologies are suitable for both onshore and offshore applications, except for SCIGs which are applied for offshore wind only. DFIGs dominate the onshore market nowadays, while SCIGs dominate the offshore market. Direct drive HTS (high-temperature superconductors) is a promising technology currently at an early stage of research.

Wind turbines are specifically designed to enhance their performance in terms of energy production, reliability, operation, maintenance, capital cost and transportation. Modern wind turbines integrate a series of highly optimised components such as generator, drive train, rotor and blade to produce the lowest possible energy costs.

A key component of a wind turbine is the generator, which converts the mechanical energy to electrical energy. There are three main types of wind turbine generators: direct current, alternative current synchronous and asynchronous. Considering the fluctuating nature of wind, it is advantageous to operate the generators at variable speed to reduce the mechanical stress on the turbine blades and drive train. Permanent magnet (PM) generators have been introduced in the recent decades in wind turbines applications due to their high power density and low mass. In particular, the Direct Drive PMSG offers certain advantages in terms of efficiency, weight, dimension and maintenance. However, this type of turbine is associated with a high demand for REEs.

The blade is another key component of a wind turbine. It allows loads to withstand the continuously varying wind speeds. These loading conditions, in combination with the low gravitational forces required, lead to a selection of materials that combine high strength-to-weight with high stiffness and fatigue resistance. Glass-fibre composite layups are commonly used for blade fabrications, although carbon fibre might represent the next standard in wind turbine reinforcement.

The REEs, i.e. neodymium, praseodymium and dysprosium, are key ingredients in the most powerful magnet material, namely neodymium-iron-boron (NdFeB). This magnet is used to manufacture permanent magnet synchronous generators (PMSG), which are used in the major wind turbine configurations. The most relevant materials required in wind power generation and the main components of a wind turbine are listed in Figure 18.

Figure 18. Raw materials used in wind turbines

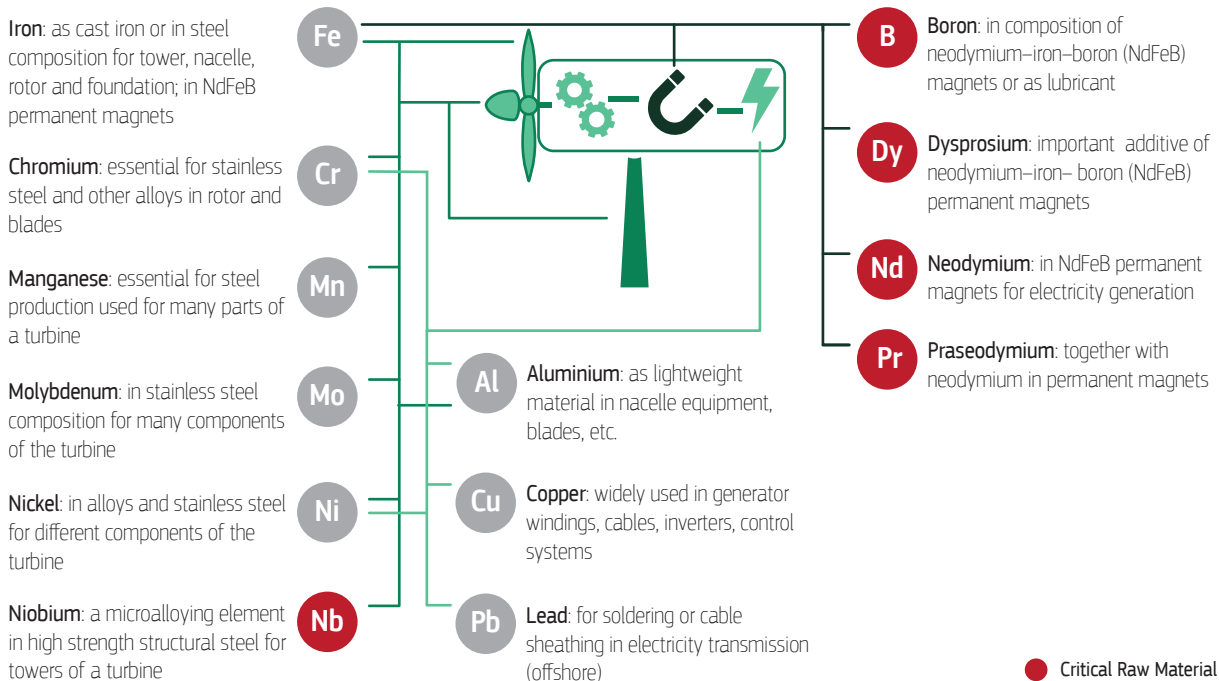

2.3.1 Current supply bottlenecks along the value chain

The cost of wind turbines is influenced by metal prices, in particular in the case of those turbines using generators containing REEs. Concerns that the supply of REEs may not be sufficient to meet the growing demand for the global transition to a sustainable energy future have grown considerably since the REEs ‘crunch’ in 2011 when near-monopolistic China imposed export restrictions.

The bottleneck assessment performed for the wind turbines shows that the risk to the supply of raw materials is the highest along the supply chain. This risk diminishes downstream through a medium risk for the supply of processed materials and component, until an undetectable risk for assemblies. Indeed, the European share increases from 1% for the raw materials, to 12% for processed materials, 18% for components, until 58% for assemblies (Figure 19).

Figure 19. An overview of supply risks, bottlenecks and key players along the supply chain of wind turbines.

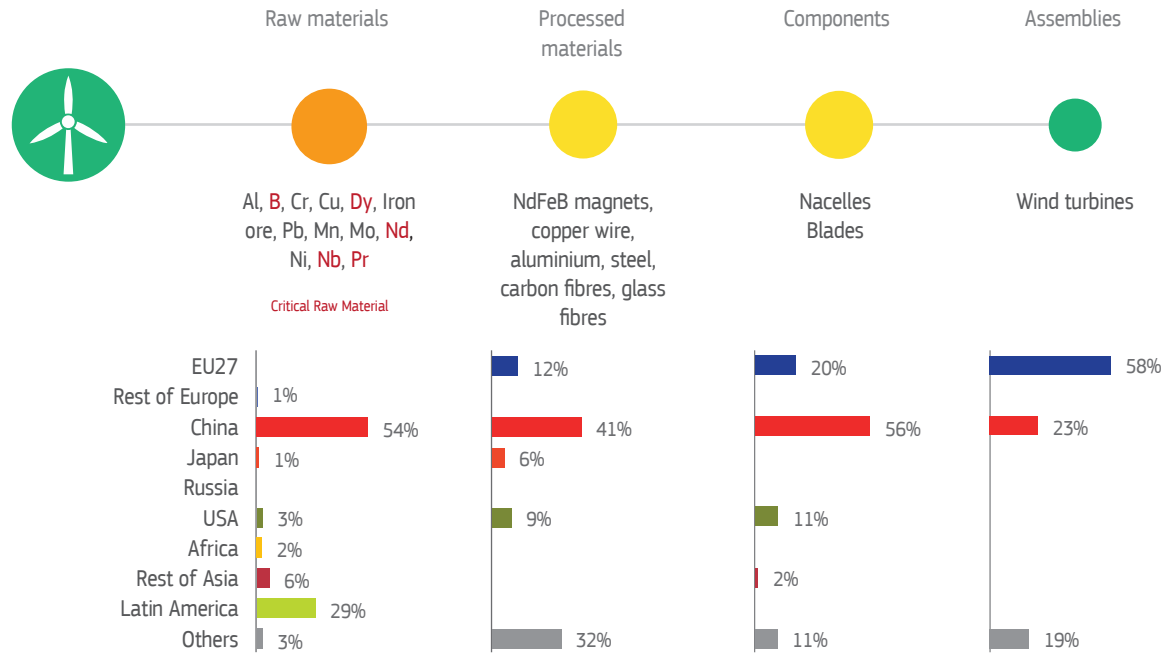



2.3.2 2030/2050 perspectives of raw materials demand

Figure 20. Onshore and offshore wind capacity in the three explored scenarios.

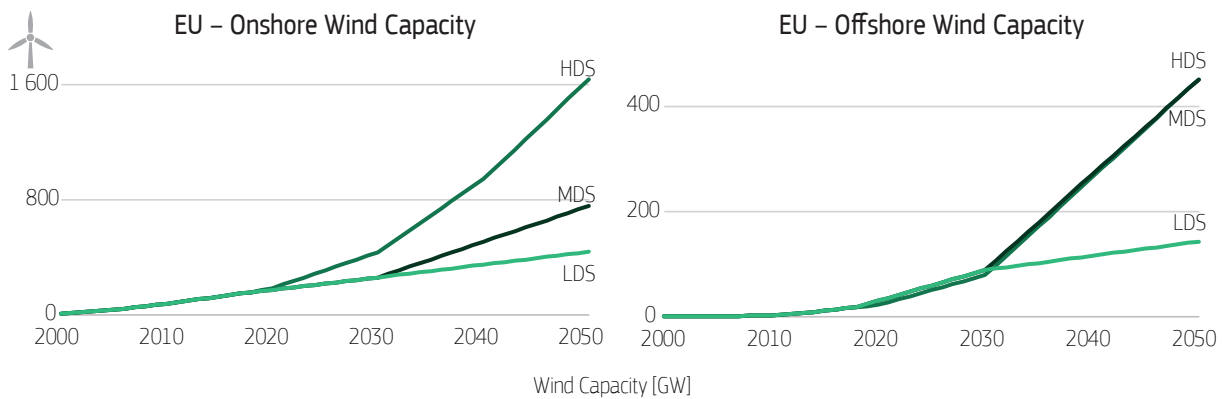

Figure 21. Onshore and offshore wind annual deployed capacity in the three explored scenarios.

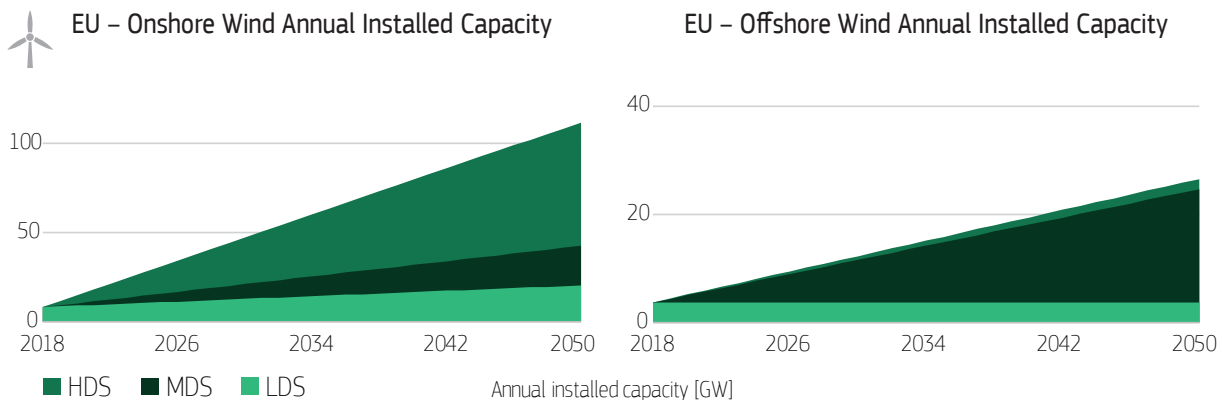

Figure 20 reports the capacity scenarios for onshore and offshore wind, respectively, according to the framework described in Section 1.2. The average lifetime of a wind turbine is assumed to be 25 years for onshore wind and 30 years for offshore wind. This value is associated to the MDS scenario. A five-year sensitivity is assumed for LDS and HDS. For more information see Annex 1 – Methodological notes, and Garrett and Rønde (2017) and JRC (2019). The combination of these lifetime values with the capacity scenarios allows calculating the yearly deployed onshore and offshore capacity (Figure 21), which is the driver of materials demand.

LDS, MDS and HDS Scenarios for the market shares are defined based on the penetration of permanent magnet generators. A moderate material intensity reduction is considered for the general materials, i.e. concrete, steel, plastic, glass/

carbon composites, aluminium, chromium, copper, iron, manganese, molybdenum, nickel and zinc. A more marked material intensity reduction is assumed for specific materials, essentially used in permanent magnets: borates, dysprosium, neodymium, praseodymium and terbium. Although with some exception, these materials are common across the considered technologies. Further details are available in Annex 1 – Methodological notes.

Results are presented aggregately for wind onshore and wind offshore. Figure 22 (overleaf) shows the annual material demand in 2030 and 2050 for the three scenarios, expressed in relative terms to the current EU consumption.

Figure 22. EU annual material demand for wind power in 2030 and 2050.

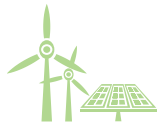

Additional material consumption for wind turbine in **renewables only** in 2030/2050 compared to current EU consumption* of the material in **all applications**



* See the methodological notes in Annex 1 and all data in Annex 2

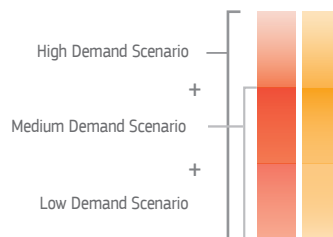



2.3.3 Key observations and recommendations

The supply risk of the REEs in permanent magnets (PM) generators for wind turbines is one of the most concerning feature of wind industry related to raw materials. Despite the price of REEs fell back to almost pre-2011 crisis level, their increasing global demand can have significant implication for the wind energy industry. Additional concerns raise over the single-market dependency (China has near monopoly on the production of not only REEs but also PMs manufacturing), the risk of price fluctuation and possible consequences of trade dispute between China and the US. However, following the price hike of REEs in 2011 the turbine manufactures have improved the material efficiency in their products, for instance the dysprosium content in PMs has drastically decreased. Although less efficient in the offshore conditions, alternatively, the wind systems can employ magnet-free induction machines for power generation.

Opportunities to improve the materials impact on the competitiveness of the EU's wind power industry (JRC, 2017b):

- ▶ *Diversifying the materials supply*: It is essential for the EU to diversify the REEs supply via partnerships and participation in various ongoing and future exploration projects at a global scale. Several mines and processing facilities for REEs are now slowly ramping up their production after long delays. Good potential for REE mining also exists in Europe, as for example in Sweden, Finland, Germany, Spain, Norway and Greenland.
- ▶ *Improve manufacturing opportunities in the EU*: Besides secure access to REEs, their processing and PM manufacturing facilities are important assets for the EU wind industry. Besides mining, the processing of REEs is a critical step due to its high environmental impact. Therefore, securing a sustainable supply of primary and secondary raw materials can also boost companies producing sintered neodymium-based magnets, which are now disappearing from the EU. Monitoring innovation and new developments (e.g. iron-nitride PMs) and being able to initiate production or timely secure contracts with producing countries are other opportunities for improving the sector's competitiveness in the long-term
- ▶ *Recycling and reuse, substitution*: One feasible way to secure future EU access to the REEs needed for wind turbines, EV motors and other high-tech applications is to ensure a sustainable flow of secondary materials through recycling. Adequate collection and recycling capacity should be established in the EU as soon as possible to deal with the increasing flows of used PMs from industrial machinery. Due to the specificity of the recycling processes, proper regulation and the introduction of a labelling system indicating the type of PMs will facilitate the recycling process and make it more effective. However, the REEs generated from recycling will not meet the primary demand in a growing market. Nonetheless, this may be sufficient, to a large extent, to secure the magnet-producing industries in EU in the short term, whilst in the long-term primary mined sources could be developed. Finding alternative technologies can drastically change the long-term picture. New advanced technologies will come with new material requirements and new suppliers. For instance, when iron-nitride PM technology is proved and commercialised in the coming years this could significantly alleviate the EU's dependency on China for wind and EV materials since this new magnet relies on more abundant and cheaper materials.
- ▶ *Promote R&D, develop skills and competences*: The development of innovative highly efficient refining, separation and recycling methods may alleviate the supply risk for some CRMs, especially REEs. Recycling technologies for REEs are still in the early stages of development and face inherent difficulties: many other devices contain less than one gram of valuable REEs; the product design is unfriendly and not suitable for the easy separation of components, which makes the recycling process expensive. In addition, there is insufficient information of the REE content of different products.

2.4 Traction motors (permanent magnets)

Figure 23. Raw materials in traction motors

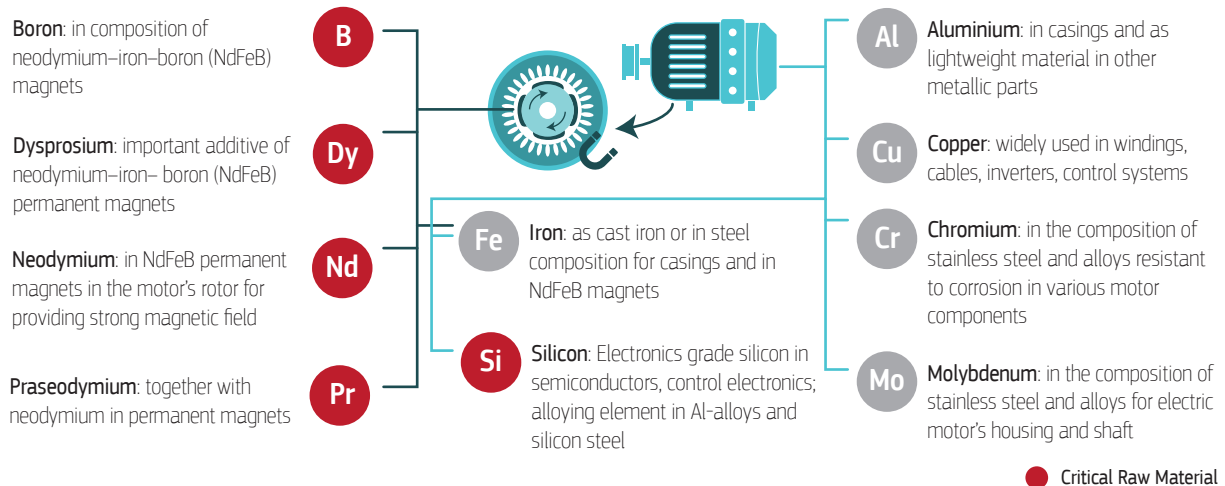

There are today about 8 billion electric motors in use in the EU, consuming nearly 50% of the electricity EU produces. These motors are used in a large range of applications from small-sized electronic products to e-bikes to large motors found in electric drivetrains in vehicles and heavy transport. The number of motors in the EU is expected to grow significantly in the future, in particular through the broad deployment of traction motors in EVs. Electrical motors for e-mobility require high performances such as high torque densities, lightweight and high efficiencies.

Most hybrid and EVs use synchronous motors with NdFeB magnets. NdFeB alloys are the strongest magnets and have the largest sales share. The family of NdFeB magnets contains REEs such as neodymium, praseodymium and dysprosium. Dysprosium is used as an additive to improve the magnet coercivity at high temperatures. The compact size and high performance of permanent magnets (PMs) makes it the favoured technology for hybrid cars: manufacturers have to cope with space restrictions due to the need to integrate two drive trains into the car (the electric engine and the combustion engine) (Pavel et al., (2017), JRC, (2017a)). Most hybrid and EVs use synchronous motors with NdFeB magnets.

Alternatives to PMs synchronous-traction motors exist: for example, induction motors adopted by several EV manufacturers. These do not contain any permanent magnetic materials and instead operate by inducing electrical currents in conductors in the motor's rotor. Such motors contain higher quantities of copper. Similarly, other manufacturers have chosen wound rotor motors that, in place of PMs on the rotor, use large quantities of copper in windings. Electric motors also contain significant quantities of base metals such as steel (including a large share of electrical steel that contain up to 6.5% of silicon), copper and aluminium (Hernandez et al., 2017).

In the future, NdFeB magnet technology is expected to dominate the market: it is expected that by 2025, between 90% and 100% of hybrid and EVs could be based on synchronous motors with NdFeB magnets (Leader & Gaustad, 2019). Still, component substitution is possible: induction and wound rotor motors could potentially play a significant role in the future, hence strongly influencing the types and quantities of raw materials used in traction motors in the future. For PMs, current research focuses mostly on reducing the REEs' content through increasing material efficiency in magnet production and by optimising the motor design, enabling high technical performance while using less NdFeB magnet. A rise in material efficiency for neodymium and praseodymium of up to 30% from 2015 to 2030 in a PM of equal magnetic strength and cost is expected. Similarly, dysprosium content in PMs in hybrid vehicles could significantly drop by 33% between 2015 and 2020 and by 66% afterwards. Moreover, researches concern replacement of rare earth magnets by other magnetic materials. For example, "low cost magnets" made of ferrite (iron oxide combined with the metals strontium, barium or cobalt) or aluminium nickel cobalt (AlNiCo) could be an option although their coercivity need to be strongly improved. Samarium cobalt (SmCo) magnets, developed in the 1970s and frequently used in aerospace applications are attractive as they can withstand higher temperatures than NdFeB but they are rather expensive for the moment. Moreover, both samarium and cobalt are classified as critical to the EU. Key raw materials of electronic motors and their functionality are shown in Figure 23.



2.4.1 Current supply bottlenecks along the value chain

Around 10 raw materials are relevant for the production of processed materials. Of these, four CRMs are included being borates, dysprosium, neodymium and praseodymium. PMs contain significant quantities of these REEs that are characterised by very high supply concentration in China as well as concerns related to environmental and social performances along the supply chain. The supply risk value for dysprosium, neodymium and praseodymium are the highest of all the materials evaluated in the 2020 CRM list, with a 100% EU import reliance and high concentration of supply. In addition, wind energy and other motors compete for these materials.

Figure 24 displays materials and components for traction motors along the supply chain. It shows that today China dominates the production of NdFeB magnets by 85–90%, the rest being produced in Japan (10%) and in other countries

in the EU and the USA. Recently, manufacture of NdFeB magnets have been continuing to move to China where access to REEs remains cheapest and more secure. A few European players are found at different stages of the REEs value chain, including a few alloys makers and magnets manufacturers in the EU that operate mainly from imported processed materials. In addition, electrical steel with special magnetic properties is the core material for every electrical motor today. Electrical steel production is rather well distributed globally in particular in Asia, USA and the EU. Production of fully assembled electric motors is dominated by Asian companies, in particular from Japan.

Overall, a high risk is identified for the supply of raw materials, while a medium level of risk is estimated for the supply of processed materials and components.

Figure 24. Traction motors: an overview of supply risks, bottlenecks and key players along the supply chain.

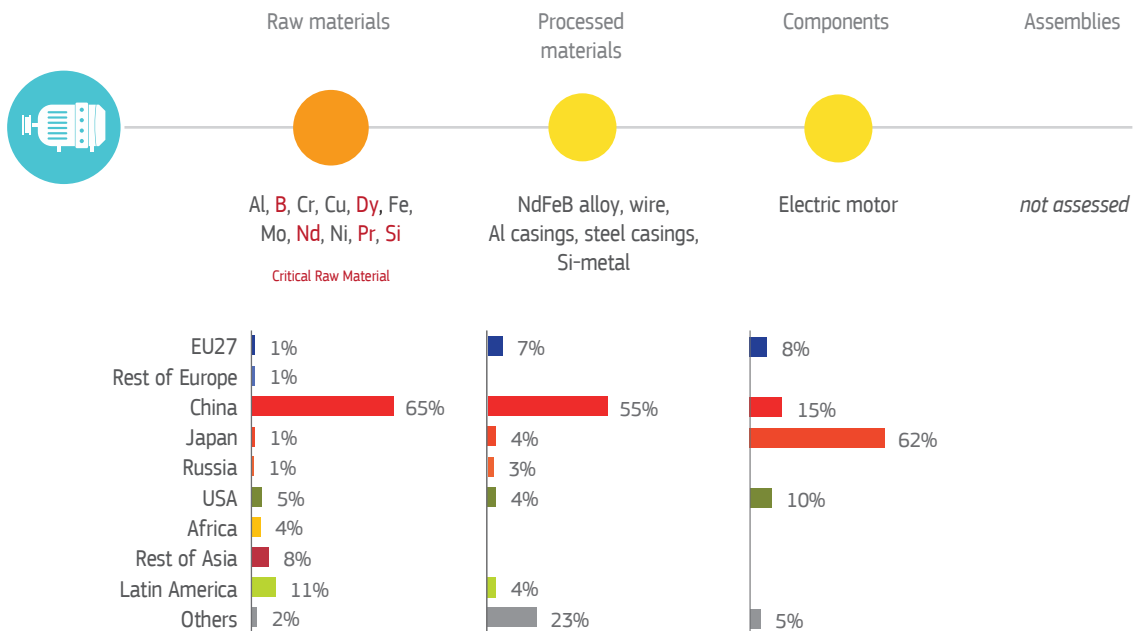

2.4.2 2030/2050 perspectives of raw materials demand

Based on the size of expected fleets of vehicles using electric motors (i.e. EVs and FCs, see Figure 25), it is possible to derive the number of electric motors put on the market and hence to derive EU annual demand of various raw materials contained in traction motors. Data for current composition of electric motors as well as forecasts for 2030 and 2050 have been derived from JRC, (2016a); JRC, (2017a) and Hernandez et al. (2017). For more information see Annex 1 – Methodological notes.

Forecasts of raw materials consumption for traction motors shows major consumption spikes for borates and REEs in Figure 26. For example, in the worst scenario, neodymium EU annual consumption for electric motors in 2050

might increase by a factor of 15 and hence reach the current EU consumptions for all applications. The future needs for borates will increase similarly although it might be less problematic for the technology because the market supply many other applications and because of their lower supply concentration.

It should be noted that these trends considers e-mobility only through EVs and do not consider e-bikes. E-bikes represent a significant application for PM electric motors because of their ability to offer low weight and compact size. Significant growth rates for e-bikes are registered in the recent years globally and they are likely to be maintained high in the next decades.

Figure 25. Fleet of vehicles using electric motors according to the three explored scenarios.

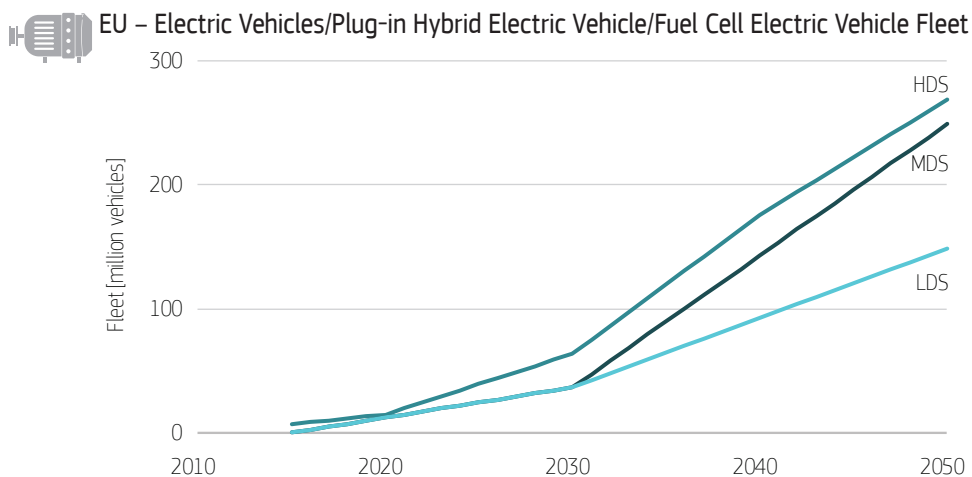
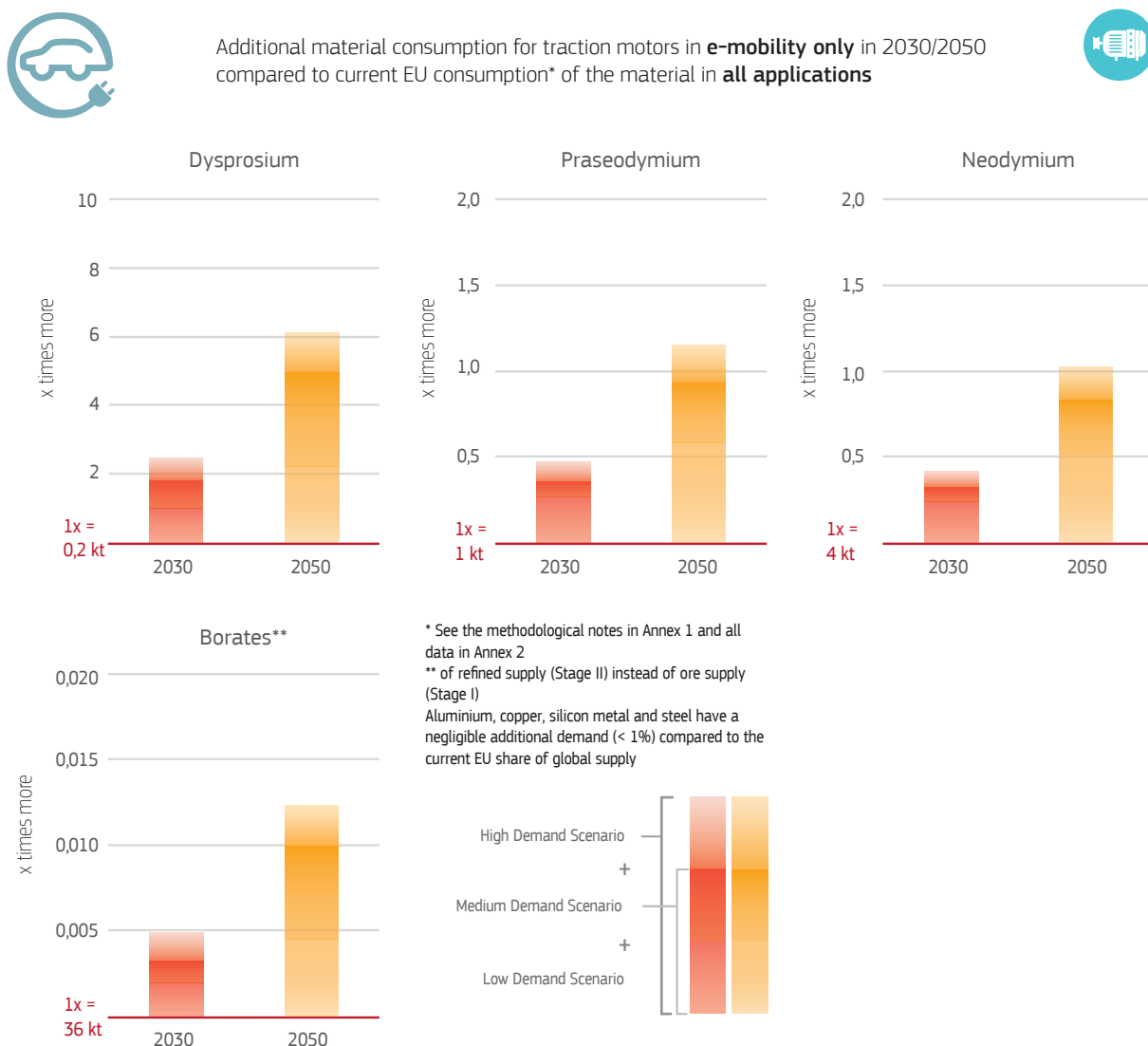

Figure 26. EU annual material demand for traction motors in 2030 and 2050.





2.4.3 Key observations and recommendations

Electric drivetrains for vehicle and heavy transport are now driving the market development of electric motors; the compact size and high performance of permanent magnets (PMs) makes it the favoured technology for traction motors; Like for wind industry, the supply risks related to the REEs in PMs are the most concerning for traction motors. This also concerns the manufacturing of PMs that is increasingly being concentrated in China. This is particularly worrisome because PM technology is expected to largely dominate the exploding market in the future and is determinant to the design of motors (and hence of vehicles). The EU still keeps some capacity on other processed materials (e.g. electric steel) of the value chains.

Hence the following recommendations, which are similar to the wind turbine technologies, with some more specific remarks:

- ▶ *Diversifying the materials supply*: Via partnerships and participation in various ongoing and future exploration projects for REEs at a global scale. Several mines and processing facilities for REEs are now slowly ramping up their production after long delays. Good potential for REE mining also exists in the EU.
- ▶ *Promote R&D investments, develop skills and competences*: The development of innovative cost-effective processing, separation and recycling methods for REEs could improve supply security for the EU. Further research into substitutes and “low cost magnets” is recommended.
- ▶ *Improve manufacturing opportunities in the EU*: developing a capacity on processing of REEs and manufacturing of PMs will be important for the EU since these stages might influence later stages of the value chain (e.g. motor and vehicle design);
- ▶ *Foster international collaboration and standardisation activities*: Ecodesign requirements are essential for fostering higher levels of reuse, remanufacturing and recycling, including the increased use of recycled content in new products to lower environmental and raw material footprints.
- ▶ *Recycling and reuse, substitution*: ensuring a sustainable flow of secondary materials through recycling could contribute to improve the future EU access to the REEs. The collection, dismantling and reuse of materials from smaller electric motors can be enhanced since currently the majority of these ‘scrap’ flows are exported to Asia. Still, long lifetime of motors and changing chemistry might be a barrier to an increased recycling input rate. Because of high reliability, traction motors can be kept longer in use and hence the material efficiency could be high;

2.5 Photovoltaics

Photovoltaic (PV) technology is used to convert solar energy to electricity and together with wind energy expected to lead in the transformation of the global electricity sector. Thanks to technological innovation, economies of scale and manufacturing experience the cost of PV energy has declined over the years leading to an enormous deployment increase around the world.

Commercial PV technologies include wafer-based crystalline silicon (c-Si) (either mono-crystalline or multi-crystalline silicon) and thin-film (TF) using amorphous silicon (a-Si), copper-indium-gallium-diselenide-disulphide (CIGS) or cadmium-telluride (CdTe). Crystalline silicon solar panels is the dominant technology accounting for about 95% of global installed PV capacity (Fraunhofer ISI, 2019). CdTe and CIGS can be deposited on flexible substrates, which makes them suitable for building-integrated or other unconventional PV applications. Amorphous silicon cells are mostly used in small-scale and low-power applications (Jean, Brown, Jaffe, Buonassisi, & Bulović, (2015))

In addition to the commercial technologies, a vast array of new PV technologies is currently being developed, e.g. multi-junction cells (typically adopted for space applications) or hybrid devices at the nanoscale level. These new concepts show potential as regards significant increases in efficiency and/or reductions in cost through improvements in device architecture and material functionality.

Beside the semiconductor materials, other materials are needed in PV systems such as silver (used as paste to collect, transmit electrons and create an electric current), silica (for high transmittance and resistant glass in PV modules), aluminium (for making the frames around the solar panels) and copper (as conductor material in cabling, earthing, inverter, transformers and PV cell ribbons). An overview of the most common raw materials used in solar PV technology and their functionality is listed in Figure 27.

Figure 27. Raw materials used in solar PV technologies

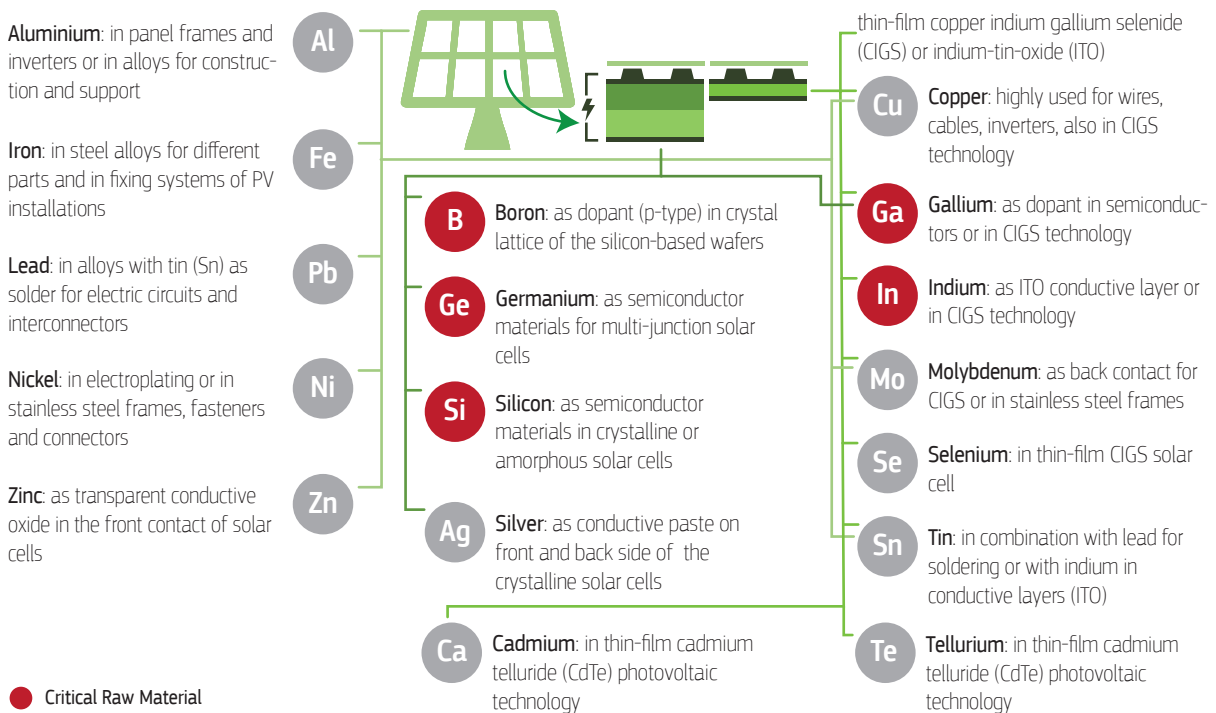



2.5.1 Current supply bottlenecks along the value chain

Solar cells and modules are often manufactured by the same companies. Manufacturers put constant efforts to improve the efficiency of PV modules while, at the same time, reducing costs and material use. The higher efficiency attained by PV cells in the laboratory indicates the potential to increase efficiency in future commercial technologies, too. In the past (2007-2008), the rapid growth of the PV industry led to an increase in the cost of purified silicon, and thus more expensive PV modules. Projected high growth rates in the PV industry and market dynamics forced manufacturers to explore the reduction of silicon and other materials in the production process. The supply risk and key country players are presented in Figure 28.

The rapid deployment of renewable energy in the EU and worldwide will put some pressure on the supply of certain relevant raw materials used in PV systems/ Some of them have a high supply risk and are defined as CRMs for the EU, such as silicon metal, indium, gallium, germanium and borates. On the other side, other raw materials such as copper, cadmium, selenium, silver and tellurium have lower supply risk. The EU supplies 6% of the raw materials used in PV systems. Many countries contribute to the supply of raw materials and therefore the supply risk at this step is considered as medium.

A similar medium supply risk is expected for the processed materials. Among all the materials used in the PV cells, silicon is the most common one. In the past, there were some issues of silicon availability because of the lack of development of new purification facilities. Today, the solar panel manufacturers still fear about potential shortages of polysilicon and

its price volatility (in fact, the price of polysilicon spiked 35% in 2017 after shutting down of several factories in China due to environmental regulations) (Ryan & Martin, 2017). China covers about 70% of the global production capacity of polysilicon with an annual production of 388 kilotonnes (Research and Markets, 2019).

The most vulnerable step along the supply chain of PV technology is at the component level, for which China dominates the supply market with about 89%. Actually, China dominates nearly all aspects of solar PV manufacturing and use. This dominance started ironically in the late 1990s as response to the increasing demand for solar panel generated by Germany incentive programme to promote rooftop solar panels. China's solar manufacturing capacity grew further in the years following the 2008 economic crisis when the Chinese government introduced in 2011 the feed-in tariff for solar PV. In 2019, the list of top 10 companies in terms of crystalline silicon cells include eight from China, one from South Korea (Hanwha Q Cells) and one from Canada (Canadian Solar), (BloombergNEF, 2020). Most manufacturing plants of crystalline silicon cells are displaced in China, but also in Malaysia, India, Taiwan, Vietnam and South Korea. According to Bloomberg, the EU manufacturing capacity for crystalline silicon cells in accounted for only 0.3% in 2019, particularly in Italy, Germany and France (BloombergNEF, 2020). A slightly higher proportion (about 1.5%) of solar modules based on both silicon and thin-film is produced in the EU, although the main production is located in Asia.

Figure 28. Solar PV: an overview of supply risks, bottlenecks and key players along the supply chain.

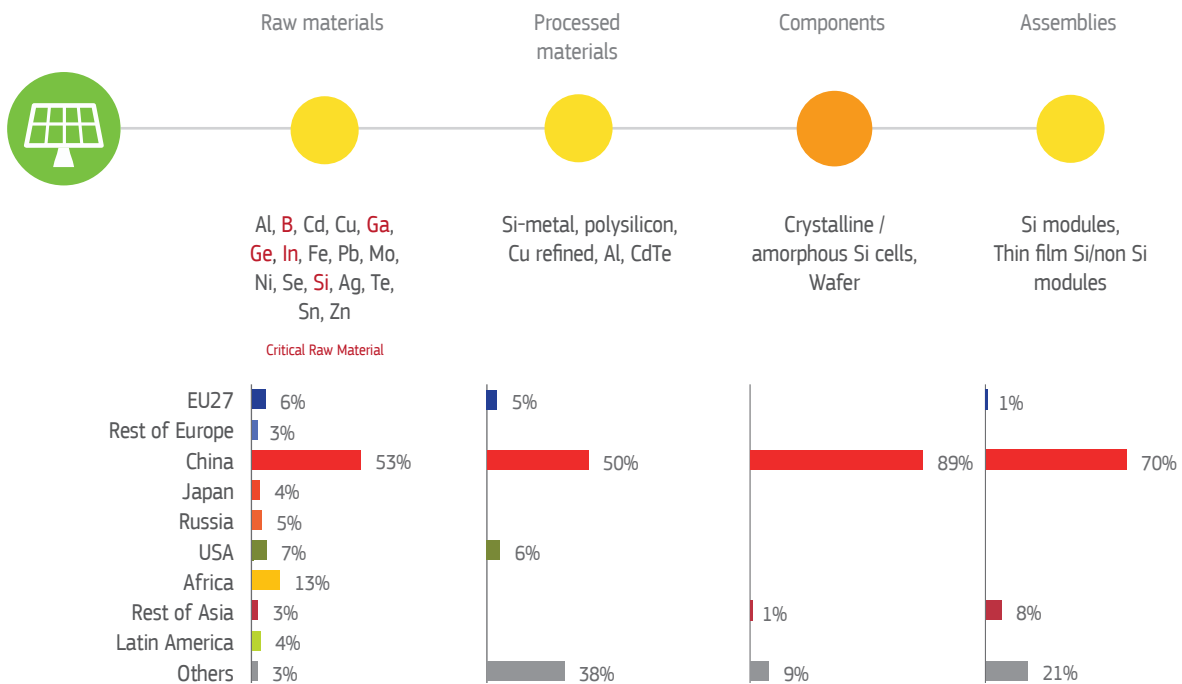

2.5.2 2030/2050 perspectives of raw materials demand

Figure 29. Solar PV total installed capacity in the three explored scenarios.

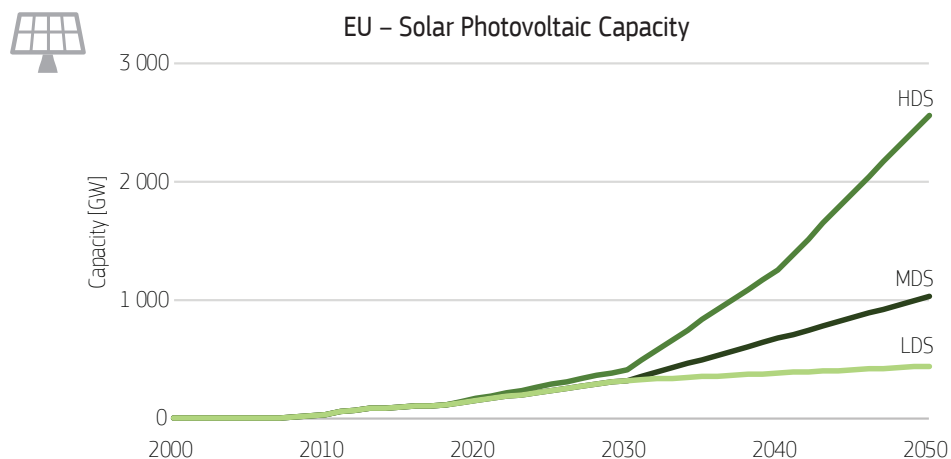

Figure 29 reports the capacity scenarios for PVs according to the framework described in Section 1. See Annex 1 – Methodological notes for more information.

The operational range of solar panels is normally 20-30 years, with a central value of 25 years (Fraunhofer ISI, 2019). Therefore the same lifetime assumptions as for onshore wind have been chosen: 30 years for LDS, 25 years for MDS and 20 years for HDS. The resulting annual installed capacity is shown in Figure 30.

The analysis considers the commercial technologies listed in the introduction to this section. The materials adopted in the production of solar cells are:

- ▶ c-Si → silicon metal, silver
- ▶ CdTe → cadmium, tellurium

- ▶ CIGS → copper, indium, gallium, selenium
- ▶ a-Si → silicon metal, germanium

Concrete, steel, plastic, glass, aluminium, and copper are additionally considered for all technologies, as they are used in the structural and electric components, similarly to wind. For all conversion and assumptions, see Annex 1 – Methodological notes for more details. The values adopted in this work are mostly based on Nassar et al., (2016). The annual demand for the considered materials in the years 2030 and 2050 is reported in Figure 31. Tellurium, germanium, and indium how the most critical demand-to-supply ratio.

Figure 30. PV annually installed capacity in the three explored scenarios.

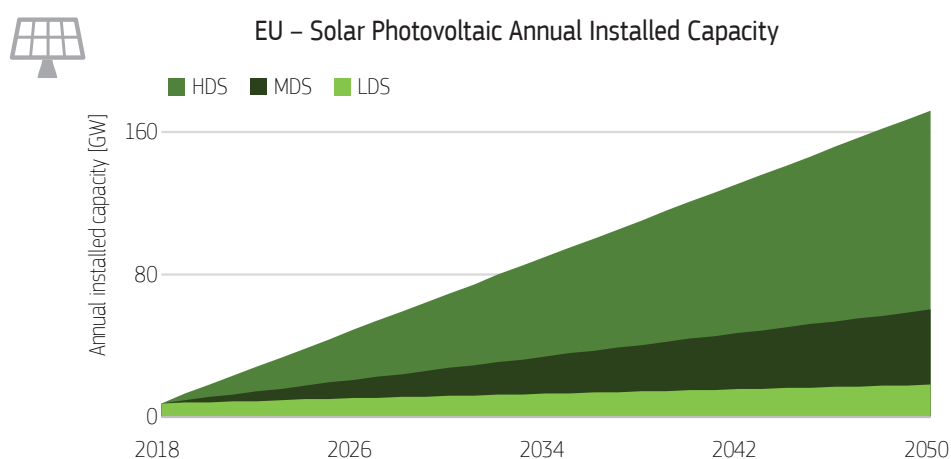
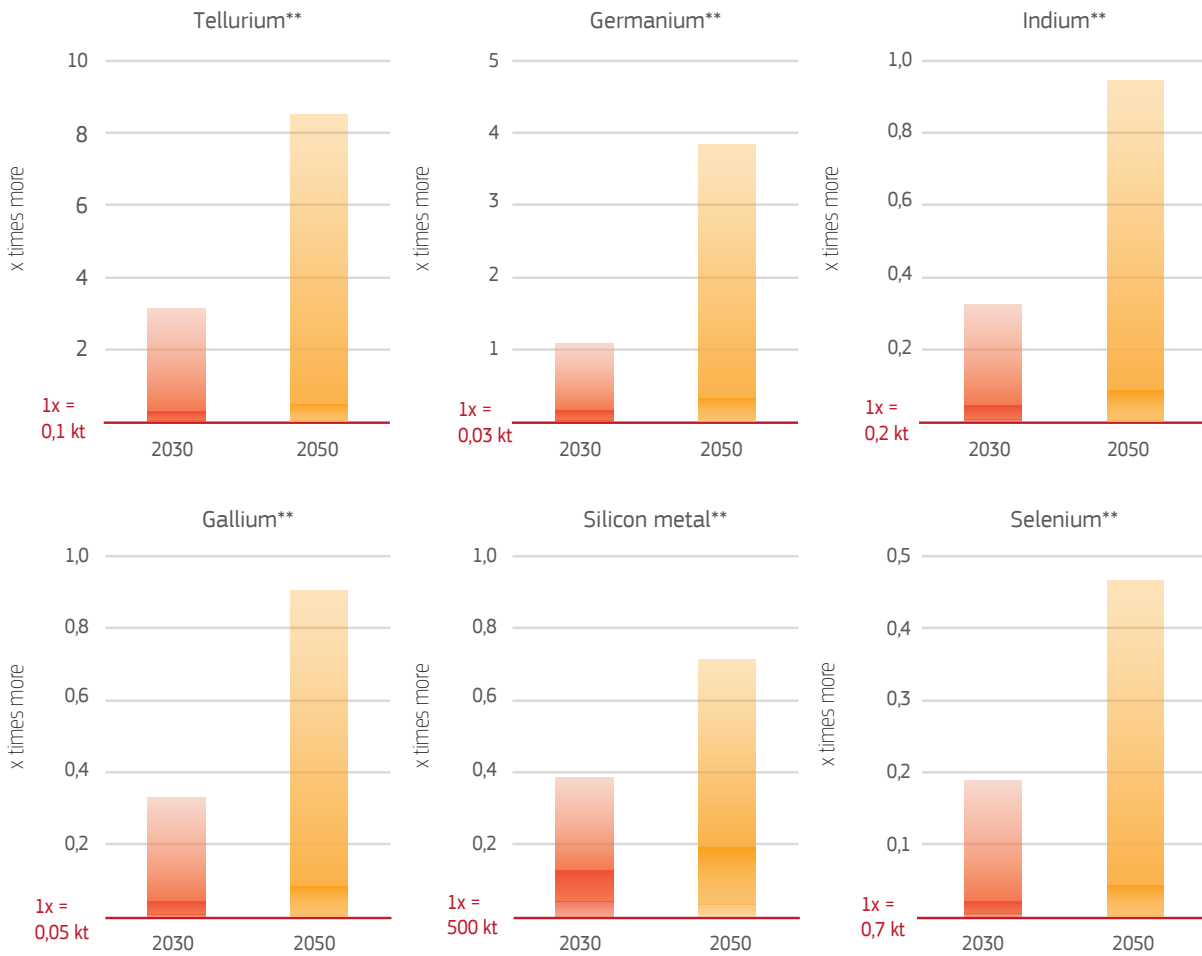



Figure 31. EU annual material demand for PV in 2030 and 2050.



Additional material consumption for photovoltaics in **renewables only** in 2030/2050 compared to current EU consumption* of the material in **all applications**



* See the methodological notes in Annex 1 and all data in Annex 2
 ** of refined supply (Stage II) instead of ore supply (Stage I)
 Aluminium, cadmium, copper and silver have a negligible additional demand (< 4%) compared to the current EU share of global supply

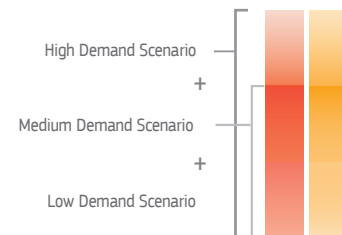

2.5.3 Key observations and recommendations

China is the leader in the supply in all four steps of the supply chain of solar PV technology. The maximum share estimated for the EU is 6% for raw materials and 5% for the processed materials step, while it lacks almost completely of production for solar cells and modules.

Opportunities to improve the materials impact on the competitiveness of the EU's solar PV industry:

- ▶ *Diversifying the materials supply:* A medium supply risk is associated with raw materials used in PV technologies. Since crystalline silicon technologies dominate the global production of solar panels, special attention should be paid to silicon. The EU is a net importer of silicon as domestic production cannot satisfy domestic demand. The reliance of the EU on imports of silicon metal is estimated to be 64%. It is challenging for the EU to be competitive in the global production of the silicon metal in particular because the processing of silicon is an energy- and carbon-intensive process. However, the EU renewable sector should remain resilient in the long-term in order to meet the decarbonisation targets and increase installation of PV capacity. Therefore, the EU will need to secure access to silicon metal from countries as the USA, Brazil and Norway.
- ▶ *Improve manufacturing opportunities in the EU:* Considering that the EU has only minimal solar cell production, it is extremely important that the EU reduces its dependency on PV cells and modules, although it will be challenging for the EU to compete with China. The EU has capacity to produce solar grade silicon. However, there is no sufficient manufacturing capacity of solar cells, which appears to be the weakest link of the solar PV value chain in the EU. Entering to the market with EU cells and modules is difficult due to lower production cost in Asia. In this regard, there is potential to expand the market segment of tailored PV products because of relatively good market prospects compared to competing world regions and customer proximity.
- ▶ *Recycling and reuse, substitution:* Recycling and reuse of solar panels are only beginning since the volume of end-of-life products is still low. Silicon metal is currently not recovered from post-consumer waste. There is some potential for recycling silicon metal from scrap in the PV industry. Most silicon scrap generated during crystal ingot and wafer production for electronic applications can be used in the PV industry due to the higher quality (purity) of the silicon metal. Yet this potential is rather limited; electronic applications account for only 2% of silicon metal end uses. Therefore, the tangible flow of recycled silicon metal for the PV industry is the industry itself. Including a recycling strategy in the manufacturing process for PV modules is important since it can ensure some secondary material flows for PV manufacturers and can also maximise their profits. Moreover, recycled silicon metal is less energy intensive than the primary form. The early adoption of recycling targets, unified for all Member States, may lead to higher recycling and recovery rates. In addition, unification of the classification of waste streams from PV panels across the EU is highly desirable.
- ▶ *Promote R&D, develop skills and competences:* Research and innovation is needed to improve material efficiency, increase recycling rates and find suitable substitutes. Innovation is a valuable asset also for the mining industry in the EU, addressing the challenge to mine deeper, recover more from the less available and less concentrated resources and use more effectively the mine tailings (considered waste) to recover materials. The development of innovative recycling methods for PV modules will allow the recovery of a larger amount of materials, reducing the demand for primary materials and thus lessening the EU's reliance on importing these materials. The European R,D&I strategy needs also to consider the improvement of perovskite solar cells or other compounds as substitutes for silicon in solar cells and bringing these concepts to higher technology readiness levels.



2.6 Robotics

Robotics is an emerging technology with enormous potential for many application fields of industry, agriculture, medicine, transportation, social services, the military, space exploration and undersea operations. Based on the function and area of applications, the market for robots is categorised into two major segments, namely industrial robots (accounting for 80% of the current market) and service robots (20% of the current market, with almost half being robots for logistics). It is expected that service robotics will displace industrial robotics in terms of sales and market value over the next two decades. Exoskeletons (or wearable robotics) are also of increasing importance gaining market share in the future for both civil healthcare and defence applications.

The technological challenges of robotics are both software- and hardware-related. Software-related challenges include the ability to perform more and more intelligent tasks by using complex software architectures. With regard to hardware challenges, continued developments in design at both the system (robot) and the component level are necessary. Main components such as gears, motors, power units, etc. need to become lighter and smaller, especially for exoskeletons. Smaller, more powerful, high-speed and precision electronics is another challenge for exoskeletons. Sensors are a critical and key component of robots.

Novel materials allow components to become smaller and lighter. For instance, the development of innovative materials (e.g. vanadium-based materials) could contribute to the creation of miniaturised, multifunctional motors and artificial

muscles. The development of smaller and more efficient power sources (batteries, FCs or other energy sources) and electric motors is specifically important for exoskeletons. Light metal alloys, such as titanium, magnesium and aluminium alloys, normally used in partnership with composites (CFCs, Kevlar, polymer–metal composites, etc.) are of particular interest for robotics due to their favourable strength-to-weight ratios. Other innovative materials such as metallic glass, printed liquid metals and liquid silicone rubber are seen as potential game changers in the field of soft robotics.

New materials and advances in making electronic skin for interactive robots are under development. Flexible (stretchable) electronics are realised via the synthesis of novel materials such as composites of soft materials with conductive fillers or via smart structural engineering and designs such as serpentine-like structures for interconnects or wires. One of the main challenges facing electronic skin development is the ability of the material to withstand mechanical strain and maintain sensing ability or electronic properties, including the fragility of sensors, the recovery time of sensors, repeatability, overcoming mechanical strain and long-term stability. More efficient robot designs require multifunctional materials, integrating processes such as sensing, movement, energy harvesting and energy storage. Such materials can change over time to adapt or heal. Recyclability and self-healing properties are therefore critical in the future design of new electronic skins.

Figure 32. Relevant raw materials in robotics

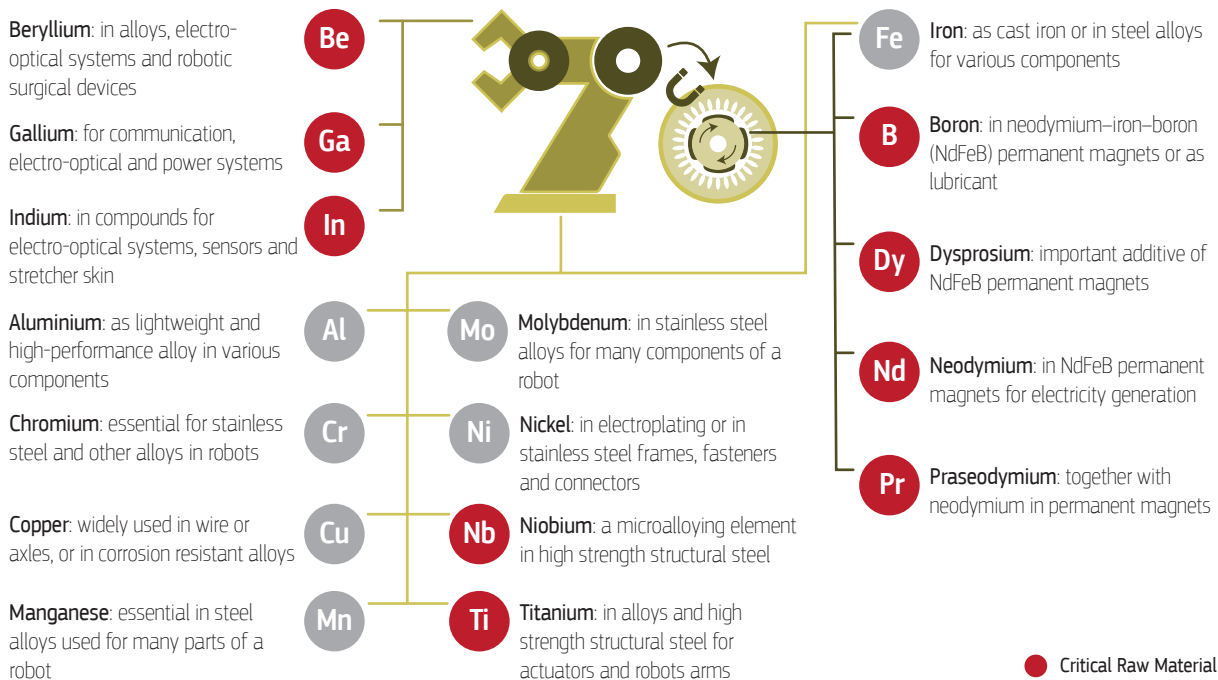

2.6.1 Current supply bottlenecks along the value chain

Figure 33. Robotics: an overview of supply risks, bottlenecks and key players along the supply chain

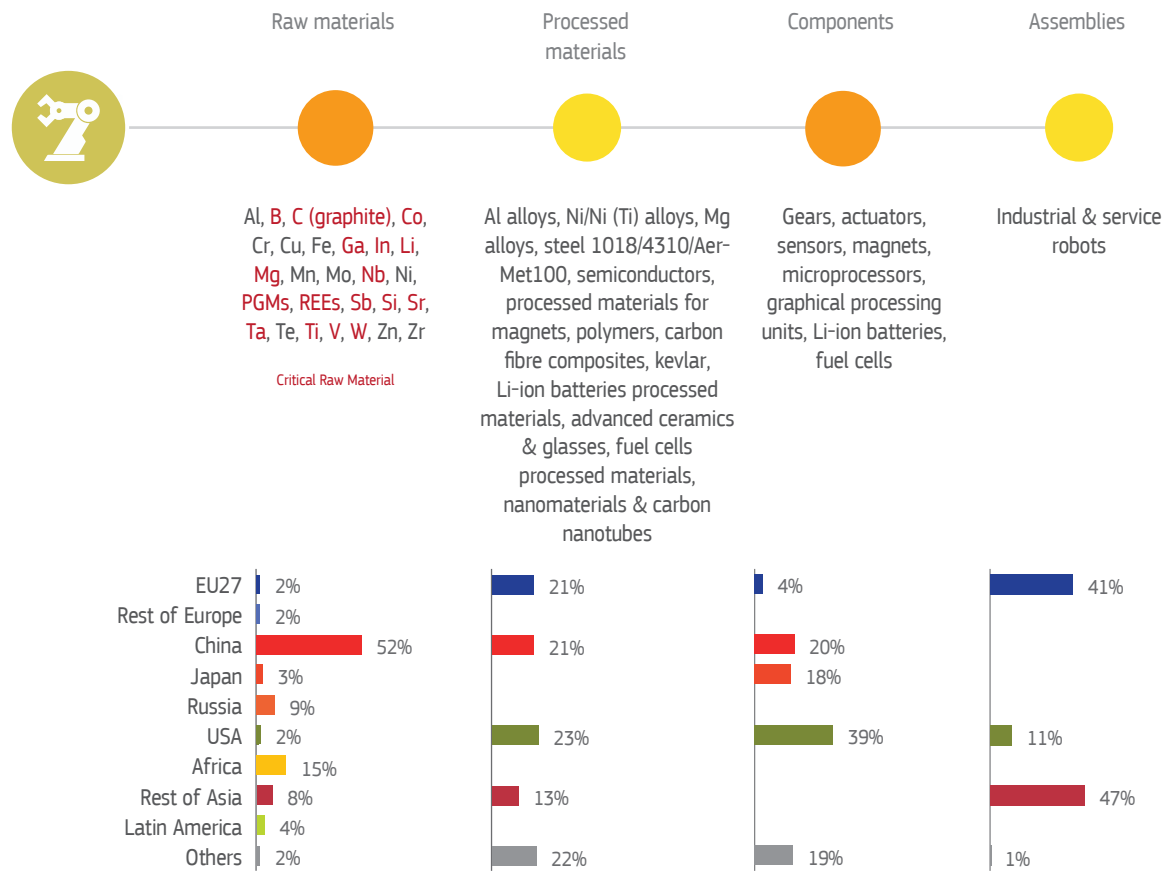

The materials functionality in robotics is shown in Figure 32, while Figure 33 gives an overview of raw materials, processed materials and components required in robotics, the key supply countries and the supply risk along the value chain.

The risk to the supply of raw materials and components is potentially high, and there is a medium risk in relation to the supply of processed materials and assemblies. In total, 44 raw materials are relevant to robotics. The EU is fully dependent on the supply of 33 materials from outside. China is the major supplier of raw materials for robotics (52%), followed by South Africa and Russia. The EU produces only 2% of the raw materials. Nineteen of the 44 raw materials are flagged as critical to the EU economy, namely tantalum, tungsten, phosphorous, fluorspar, ruthenium, rhodium, gallium, indium, borates, palladium, platinum, REEs, bismuth, antimony, vanadium, magnesium, natural graphite, silicon metal and cobalt. Almost 25% of the materials for robotics are supplied by numerous smaller countries, providing significant opportunities for supply diversification.

The EU is among the largest producers of processed materials (>20% production share), along with the USA and China. There are also possibilities to diversify the supply of the processed materials. However, it should be noted, that the EU is fully dependent on the supply of several processed materials used in robotics such as specific aluminium alloys, semiconductors and aramid (Kevlar) fibre, for which the USA and India (for aluminium alloys) are key suppliers. Moreover, potential bottlenecks could also occur in the supply of specific steels required in robotics, along with processed materials for Li-ion batteries.

The largest manufacturer and supplier of components is the USA, followed by China and Japan. The EU, with a marginal production share of 4%, is vulnerable in relation to the supply of components. The EU is particularly dependent on the supply of six key components, namely microprocessors, gears, graphics processing units (GPUs), magnets, Li-ion batteries and FCs. The USA are the major supplier of actuators, controllers (microprocessors) and GPUs, and one of the key suppliers of sensors and FCs. Japan is the key supplier of gears, sensors and FCs. China is the major supplier of Li-ion batteries



and magnets. Other key suppliers are Israel (actuators), South Korea (microprocessors and FCs) and Canada (FCs). The EU is one of the three major suppliers of sensors and actuators.

The EU is strongly positioned in the last step of robotics supply chain, i.e. the supply of industrial and service robots. Asia, mainly represented by Japan, leads the industrial robotics market with 47% production share followed by the EU (41%), while North America (mainly the USA) is better positioned in non-industrial robots. The USA also has the biggest number of highly innovative robotics companies.

The EU is also strongly positioned and is a major player in the market of service robots followed by North America and Asia (Figure 34). The EU is leading the market for civil exoskele-

tons, followed by the USA (27%), Japan (11%) and numerous smaller players. The main application for exoskeletons is currently the medical sector, followed by the industrial sector.

Though the EU is one of the major producers of industrial and service robots, the highly concentrated supply and the expected rapid growth in demand are factors contributing to the medium supply risk assessed for the last step of the supply chain. Moreover, the lack of raw materials and components, the lack of a sufficiently skilled work force in the EU and the increasing competition from China (acquisition of leading European robotics companies by Chinese companies) are additional factors that may challenge the competitive position of the EU on the global market.

Figure 34. Country production share of service robots (left) and exoskeletons (right).

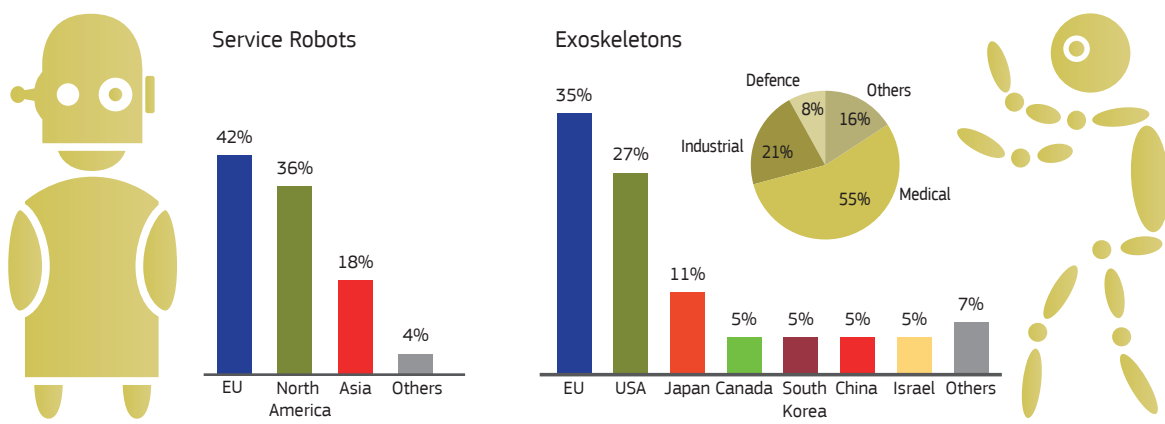

2.6.2 2030/2050 perspectives of raw materials demand

An overall increase of about 10% Compound Annual Growth Rate (CAGR) is projected in the coming years for the robotics market in general, and a moderate growth of <8% CAGR is expected in the industrial robotics sector (Statista, 2016). The most rapidly growing robotic sectors will be consumer (>20%) and commercial robotics (>13%). For specific service fields such as medical robots, a growth of >20% is anticipated. The global robotics market is expected to reach circa USD 126 million (more than 3 million units to be sold) by 2025 and USD 494.7 billion by 2040, accounting for more than 28 million units (The Business Research Company, 2018). Although the market for industrial robots is expected to experience slower growth in the automobile industry, the rising demand for automation in other manufacturing industries is creating a strong push for industrial robot manufacturers to diversify their portfolio further.

According to robotics industry representatives, there is huge potential for growth in the service robots market, in contrast with to the more mature industrial robots industry, which has more competitors, less profit differentiation and tighter profit margins.

The large-scale uptake of robotics will depend to a certain extent on the further development of new advanced materials. It is difficult, if not impossible, to quantify the raw materials demand in the future as there are too many variables that could still affect the commercialisation, such as new sectors adopting robots, the evolution of design and advanced materials, etc.

2.6.3 Key observations and recommendations

Robotics is an emerging technology offering enormous potential for applications. The technological challenges are both about software and hardware. Materials engineering, design, electronics and software are some key areas in which research is needed.

Out of the 44 raw materials used in robotics, 19 materials are flagged as critical for the EU economy. China is the major supplier of CRMs for robotics, delivering more than 40% of CRMs, followed by South Africa (10%) and Russia (9%).

It is difficult to predict the growth rate and the materials demand in robotics due to the variety of sectors involved. The highest growth is expected in the service sectors – e.g. logistics robots – but a lower growth rate of between 10% and >20% is forecast for other branches of the industrial and service robotics market. Growth projections for exoskeletons, also used across various sectors, are even more optimistic, forecasting a CAGR of up to 40-50% in the next few years.

At the level of raw materials, it is important to secure access and diversify the supply for those materials used in robotics and for which the EU has no or very low domestic production such as chromium, cobalt, molybdenum, natural graphite, nickel, magnesium, vanadium, copper, tin, antimony and bismuth.

Several actions are needed regarding the robotics supply chain such as:

- ▶ *Diversifying the materials supply:* China is the major supplier of more than one third of the raw materials required in robotics. Other suppliers are South Africa (7%) and Russia (6%) with many small suppliers having less than 6% market share, which gives vast opportunities for supply diversification.
- ▶ *Improve manufacturing opportunities in the EU:* The dominance of foreign suppliers, specifically for some higher-level components that are expected to be key components for future technological development (e.g. GPUs), is seen as a threat by the robotics industry. Strengthening and investing in the local components manufacturing industry would be profitable for robotics companies. It would increase production in the EU and prevent companies from setting up manufacturing plants in Asia. In addition, this would establish a new revenue stream for the EU through selling technologically advanced robotic components to robot manufacturers in other countries. The European Commission could invite Member States to define appropriate incentives for existing local robotic-components-related companies to invest in the EU, and support the development of new businesses. In addition, measures to discourage the inflow of components produced outside the EU could be defined again at Member State level.
- ▶ *Recycling and reuse, substitution:* The eco-design of robotic products should be incentivized to ensure a more efficient use of materials and energy as well as easy disassembly of components and materials identification, their reuse or recycling, including exoskeletons (or wearable robotics).
- ▶ *Promote R&D, develop skills and competences:* Development of advanced light and high-strength structural and functional materials is the main research line for robotics. Promising materials appear to be magnesium, aluminium, titanium alloys, special steels and composites (fibre reinforced), including combined polymer–metal composites. Providing funds for robotics research in terms of size, weight, technology, software, materials and applications is expected to significantly influence the European robotics market. Great emphasis should be put on SMEs as a growth strategy of the European civil and defence robotics market. With regards to robotic components, it is necessary to further develop smaller, more powerful, high-speed and precision electronics including the cyber physical security of electronics systems (such as controllers). This last aspect is a key issue as robotics systems develop increasing levels of autonomy, artificial intelligence and software integration. Therefore R & D investment in methods to protect robotic systems and critical infrastructure against cyber supply-chain attacks will be required. In the field of exoskeletons research opportunities are on the software field to coordinate exoskeleton movements, vital-sign- and stress monitoring technologies, visual augmentation systems/operators, automated remote sensors for increasing situation awareness, reducing the surveillance, and improving communications connectivity.
- ▶ *Ensure a sufficient high-skilled work force to attract and maintain robotics technical expertise:* Robotics companies in the EU already perceive this as being a big potential bottleneck for the future development of this sector in the EU. Companies are interested in hiring enough high-level maths software engineers and people with robotics PhDs. The main competition in skilled work force is expected to come from China and India. Therefore, both companies and academia should be encouraged to identify skills gaps and skills shortages for the robotics sectors. Tailored retraining and skill-raising programmes can be an important follow-up, which the European Commission can support. It is also up to stakeholders (industry, academia, etc.) to take advantage of relevant EU funding, such as Erasmus and European Structural and Investment Funds.



2.7 Drones (Unmanned Aerial Vehicles or UAV))

Unmanned Aerial Vehicles (UAVs) are aircrafts that do not carry a human operator, use aerodynamic forces to provide vehicle lift, and can be expendable or recoverable (commonly known as drones). Starting from the 1970s, the civil applications of drones gained ground, and civil drones are clearly dominating the market regarding the number of units, with over a million units sold by 2015 in various fields of application such as agriculture, provision of data for science, logistics and commerce. However, the market size in terms of value is still dominated by military applications, followed by commercial and hobby applications (Statista, 2019).

Drones are used for various civil and commercial applications. These comprise remote sensing for aerial monitoring and investigation for agriculture, infrastructure inspection, border monitoring and surveillance, research and development, and other data-collection processes, along with the transport of goods, for example parcels in the logistics sector (JRC, 2019a). A chart with an overview of drone applications is provided in Figure 35 based on EPRS (European Parliamentary Research Service, 2019).

The defence market is today dominated by large UAVs, and it is expected that this will remain the case for the next two

decades. The defence industry has in recent years witnessed a growth in the application of other types of drones and cybersecurity. C4ISR (command, control, communications, computers, intelligence, surveillance and reconnaissance), cyber security, embedded computing and UVs are key applications with potential growing markets. Figure 36 depicts an overview of the raw materials adopted in drones.

To realise these applications, like any modern aircraft, drones are composed of numerous components, often up to several hundred individual parts. As drones can basically be considered a special type of robot, the composition and components are similar. Typical robot assemblies are motors, power units and conductors, controllers, electronics, wheels, axles, supporting structures, etc., while drones have certain additional assemblies like wings, rotors, and specific sensors or components necessary for aerial navigation. The main assemblies are the airframe, propulsion systems, actuators, avionics, connectors, weapon systems (defence) and surveillance systems. As can be deduced from figure 35, several general functionalities rely on the same components for both civil and military use.

Figure 35. Drones applications

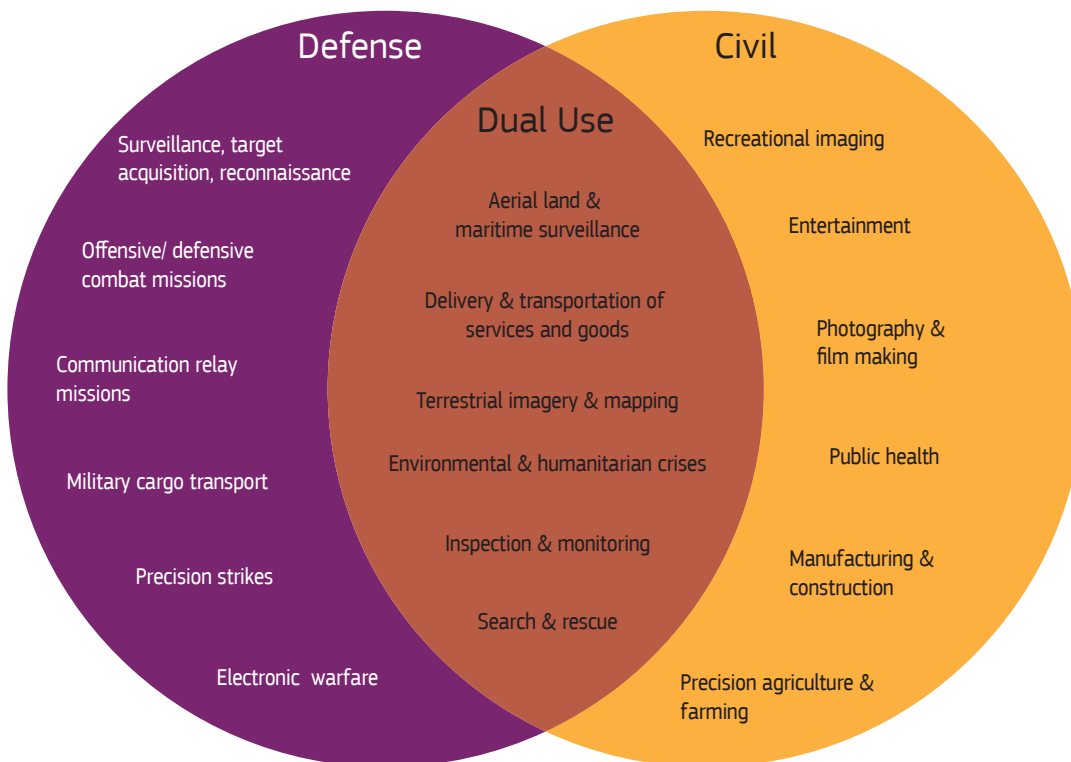

Source: Adapted from (EPRS | European Parliamentary Research Service, 2019).

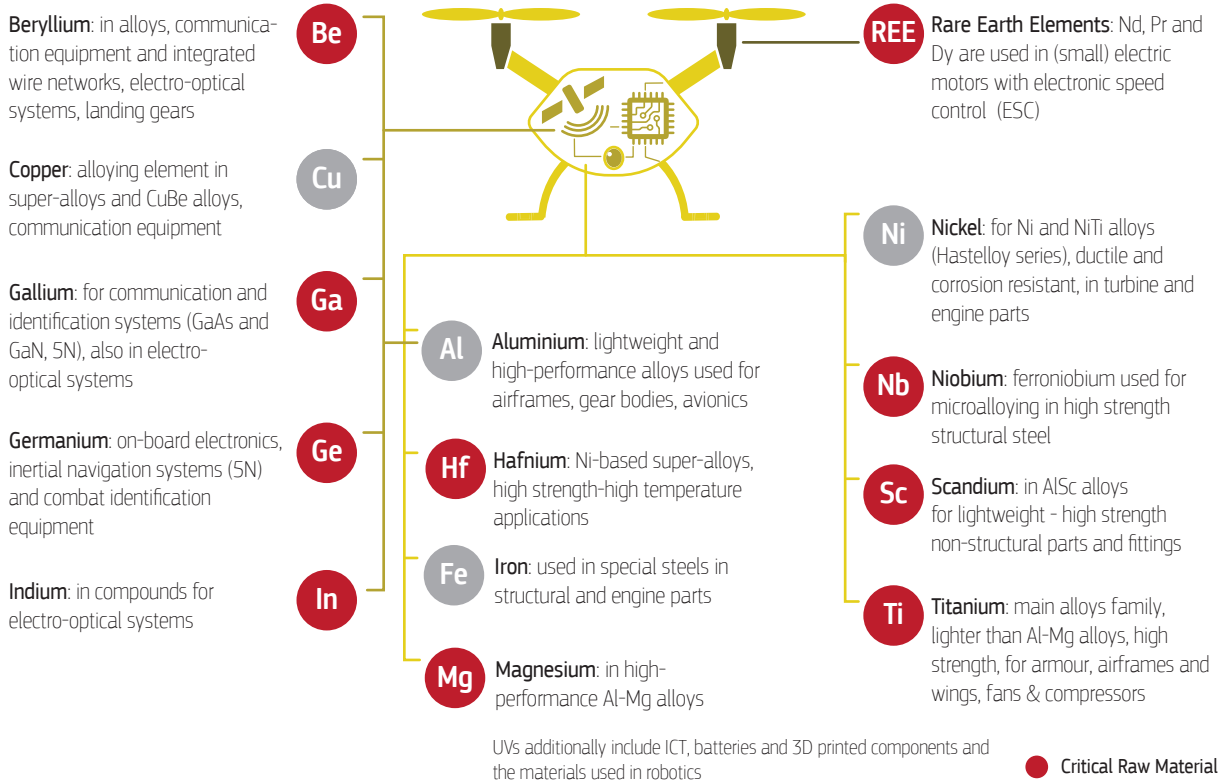
Figure 36. Raw materials in unmanned vehicles (drones).

2.7.1 Current supply bottlenecks along the value chain

An overview of raw materials, processed materials and components required for this technology, the key supply countries and the supply risk along the value chain is presented in Figure 37.

The dimensions, technologies and materials used in larger UAVs are also analogous to those in manned aircrafts. Due to their complex systems, a wide range of materials are relevant for drone production. In total, 48 raw materials are identified as relevant. The EU is fully dependent on the supply of 40 of these. The materials of particular importance are REEs, magnesium, bismuth, and tungsten, for which the dominant supplier is China, and niobium, for which the dominant supplier is Brazil. 15 materials, namely cobalt, lithium, titanium, silicon, natural graphite, magnesium, vanadium, antimony, bismuth, borates, indium, gallium, tungsten tantalum, niobium, beryllium and hafnium as well as the materials groups of the REEs and PGMs, are flagged as critical to the EU economy (European Commission, 2020). China is the predominant supplier of most of the CRMs for UVs, providing more than 39%. South Africa and Russia are the next major suppliers of CRMs, with a 13% and an 6% share of global production respectively. The supply of CRMs from European countries is 13%.

14 processed materials are identified as relevant for drones, namely: aluminium alloys, aluminium-magnesium alloys, magnesium alloys, nickel alloys, nickel-titanium alloys, titanium alloys, speciality steels, high-performance alloys, refractory metals, composites (CFCs), aramid (Kevlar) fibres, semiconductors, ferroniobium and magnetic alloys. Similarly to robotics, processed materials for lithium batteries, motors

and FCs are also considered in the 'processed materials' supply-chain step.

Compared to the other parts of the UAV supply chain, the EU is well positioned with regard to the supply of processed materials, with a share of more than 27%. Other countries provide the remaining shares of the processed materials. For seven of the relevant processed materials, the EU share in global production is above 30%, and for certain alloys the EU even dominates the global supply (aluminium-magnesium alloys, titanium alloys, high-performance alloys). However, for the remaining materials, Europe's share of global production is below 20%, implying a potential need to diversify the supply sources. For certain processed materials, the EU shows a strong dependency on imports due to insignificant shares of global production, namely for semiconductors, aramid fibres (Kevlar) and ferroniobium. For these, potential supply bottlenecks could occur.

The most important supplier by far of components for drones is the USA (42%). The picture for the EU is very heterogeneous, depending on the specific types of components. The EU holds a solid share of global Inertial Measurement Unit (IMU) production, navigation and control systems, and sensors (all >20%), and even dominates the global production of communications systems. For actuators, the EU has a market share of at least 11%.

However, for the other five components, the EU depends to a very high degree on foreign production. Japan is the key supplier of gears, sensors and FCs. China is the main supplier



Figure 37. Unmanned vehicles (drones): an overview of supply risks, bottlenecks and key players along the supply chain.

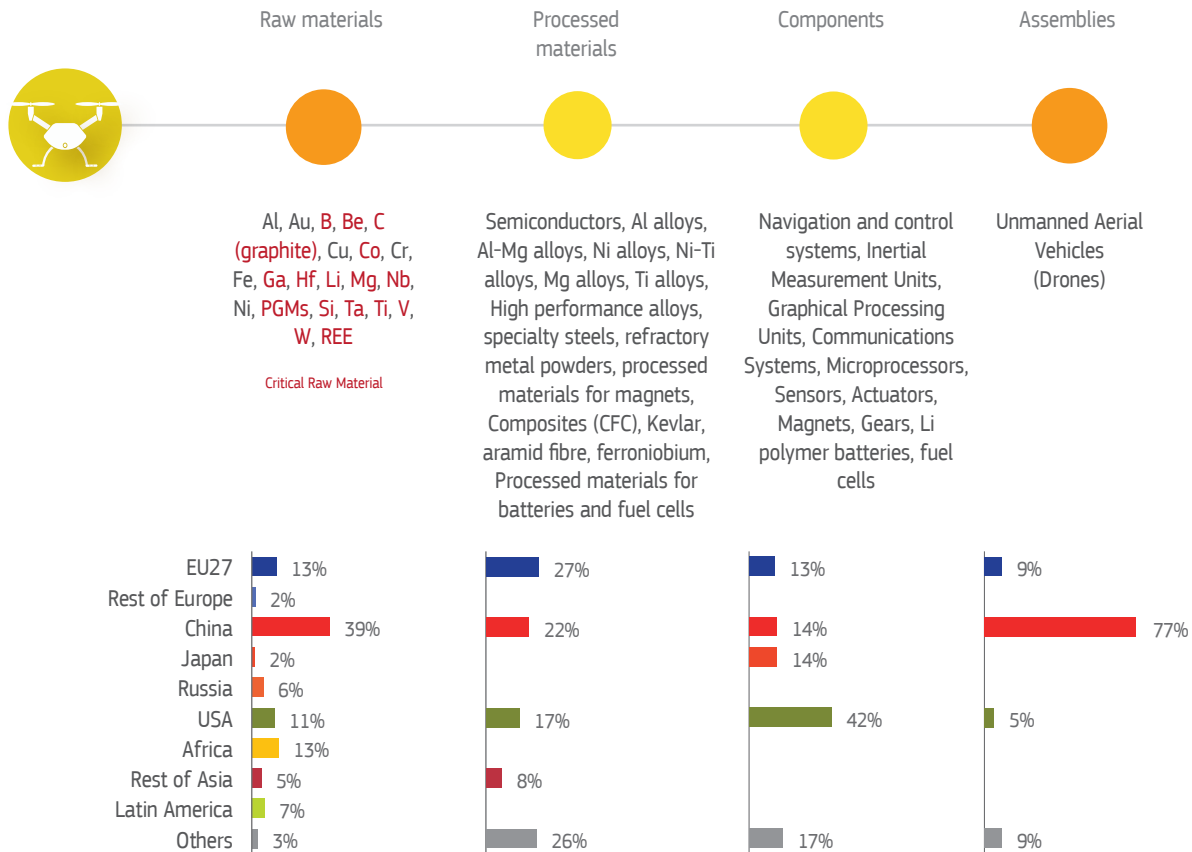

of lithium polymer batteries and a key supplier of sensors. Other key suppliers are Israel (actuators), South Korea (microprocessors and FCs) and Canada (FCs, IMUs, navigation and control systems). Potential supply bottlenecks concern in particular components for which global production is concentrated in only a few countries. This applies to GPUs, gears,

microprocessors and actuators. In particular, GPU production shows an extraordinary high concentration in the USA (95%). As for the manufacturing of civil drones, China is the market leader by far, with a global market share above 75%. Far behind, the EU is the second-largest supplier of civil drones (9%), followed by the USA (5%) and Israel (3%).

2.7.2 2030/2050 perspectives of raw materials demand

Small drones will dominate the civil and commercial sub-sectors until 2035. However, by 2050, larger civil drones can start to make an important impact on the market (more than 20%), because mobility applications will rise exponentially (reaching circa 20% of the total professional market). These types of UAV, for applications such as urban air mobility (aerial taxis), would require to be certified in the future. Large drones will stay behind in terms of unit numbers (15 000 versus 400 000).

Based on the developments in the drones market for defence applications, it can be predicted that the impact of drones on surveillance will be significant. Autonomous and robotic systems are expected to make a significant change to military operations within the 2021-2040 time frame, at both the global scale and the national scale.

Figure 38. Forecast number of drones per type of activity.

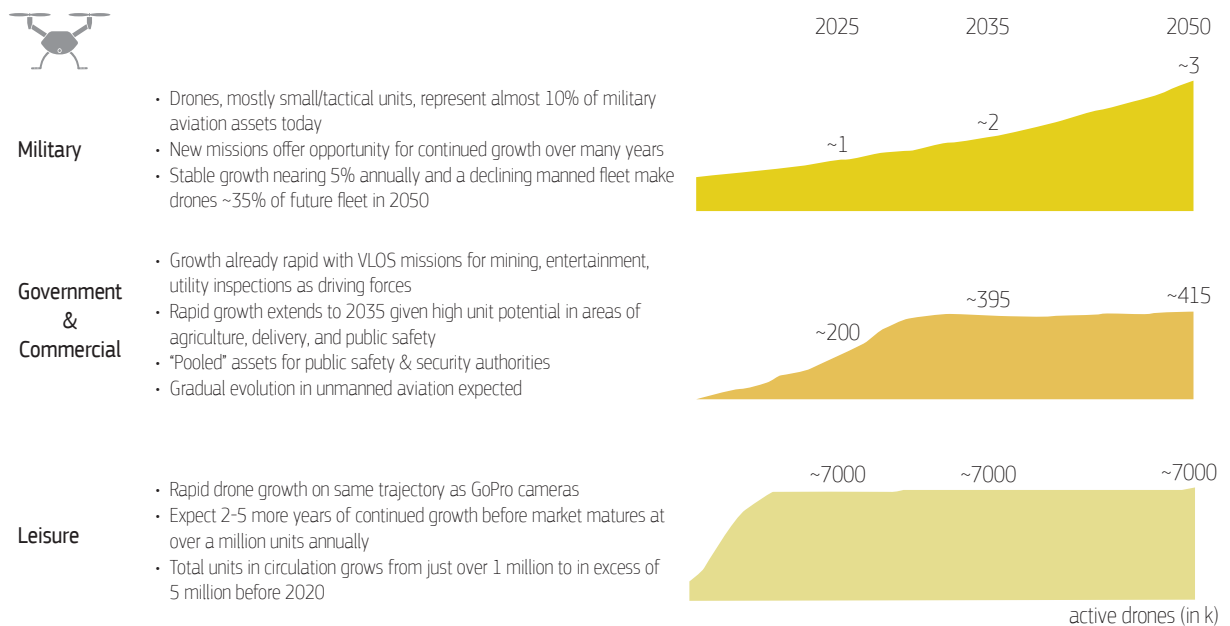

Source: adapted from (SESAR Joint Undertaking, 2016).

2.7.3 Key observations and recommendations

China dominates the civil drones sector, and increasingly the share of professional drones, while the USA and Israel dominate the military drones sector. The EU faces a serious risk of missing the opportunity to catch up with these global leaders on this key technology, which will be decisive for integrating comprehensive real-time geo-referenced intelligence into professional (civil) as well as military applications. The EU is highly dependent on external suppliers for raw materials and components as well as for the final product. China is the predominant supplier of raw materials. Downstream, the market is increasingly competitive, with the USA strongly dominating certain components (e.g. IMU, GPU and microprocessors) and drones with advanced capabilities in the military sector.

Of the 48 raw materials, 15 materials, namely cobalt, lithium, titanium, silicon, natural graphite, magnesium, vanadium, antimony, bismuth, borates, indium, gallium, tungsten tantalum, niobium, beryllium and hafnium as well as the materials groups of the REEs and PGMs, are flagged as critical to the EU economy. China is shown to be the major supplier of CRMs for drones, delivering more than 40% of CRMs.

The following recommendations are made:

- ▶ *Diversifying the materials supply*: It should be noted that more than 50% of the raw materials are supplied by numerous smaller supplier countries, providing good opportunities for supply diversification
- ▶ *Promote R&D, develop skills and competences*: The Materials for Dual-Use report (Blagoeva et al., 2019; JRC, 2019b) recommends the intensification of R&D efforts on selected key strategic components, assemblies, and on certain larger military UAVs to reduce the EU's dependence on imports, as well as the streamlining of military procurement in the EU to boost efficiency and dynamism. Software design skills also need to be supported and strategic alliance(s) should be considered.
- ▶ *Foster international collaboration and standardisation activities*: Advancements in EU regulation and standardisation are necessary but not sufficient to make the EU a leading supplier of drones globally.



2.8 3D printing (Additive manufacturing)

3D printing (3DP) is a new technology that disrupts traditional supply chains and replaces conventional manufacturing technologies. 3DP is an umbrella for a wide variety of technologies such as electron beam and laser melting based systems as well as binder jetting and nozzle processes using metal powders, wire and arc additive manufacturing (cladding) using metal wire and various laser polymerisation and other techniques covering the production of polymer based parts. 3DP has a high potential to reduce supply risk for high performance, lightweight components and assemblies (JRC, 2019a).

3DP offers specific advantages: It allows for more prototyping and design freedom, substantial weight reductions via optimised designs and more complex geometries and it enables customisation to be integrated in serialised production. In addition, 3DP offers repair possibilities of existing parts and flexible decentralised production. In various manufacturing sectors, there are significant shifts due to eliminating of multiple manufacturing stages by the new technology. The weight saving potential in aerospace is already maturing fast and in the case of defence, the production of highly tailored parts at remote locations offers many benefits in supporting strategic, tactical planning and troop field support. 3DP is rapidly maturing. Key challenges are achieving sufficient quality and lowering production cost and consistency in production in particular to meet industrial certification.

For metal-based 3DP the main technologies are powder bed fusion (PBF) using lasers (SLM, SLS, DMLS, see glossary), direct energy deposition (DED) technologies (LPD, LENS, DMD, SLC, see glossary), binder jetting/nozzle systems (3DP and droplet deposition) and electron beam manufacturing (EBM) technologies (LBM, EBM, WAAM, see glossary). When excluding 3DP of polymers and their related technologies, the majority of processes use metal powders. Although less developed, the main advantage of metal wire products is a more homogenous distribution of alloying elements and the possibility to create customised alloys by means of dual-wire feeding systems. The most common alloy families used are powders of aluminium-magnesium, titanium, nickel, stainless steel and special alloys. These alloys families use specific quantities of additional alloying elements providing various material properties. The most relevant alloying elements for 3DP are subsequently cobalt, hafnium, niobium, magnesium, scandium, titanium, vanadium, tungsten and zirconium. Various titanium alloys are used for high strength and light-weight applications.

An overview of the raw materials used for 3DP is reported in Figure 39.

Figure 39. Raw materials in 3D printing.

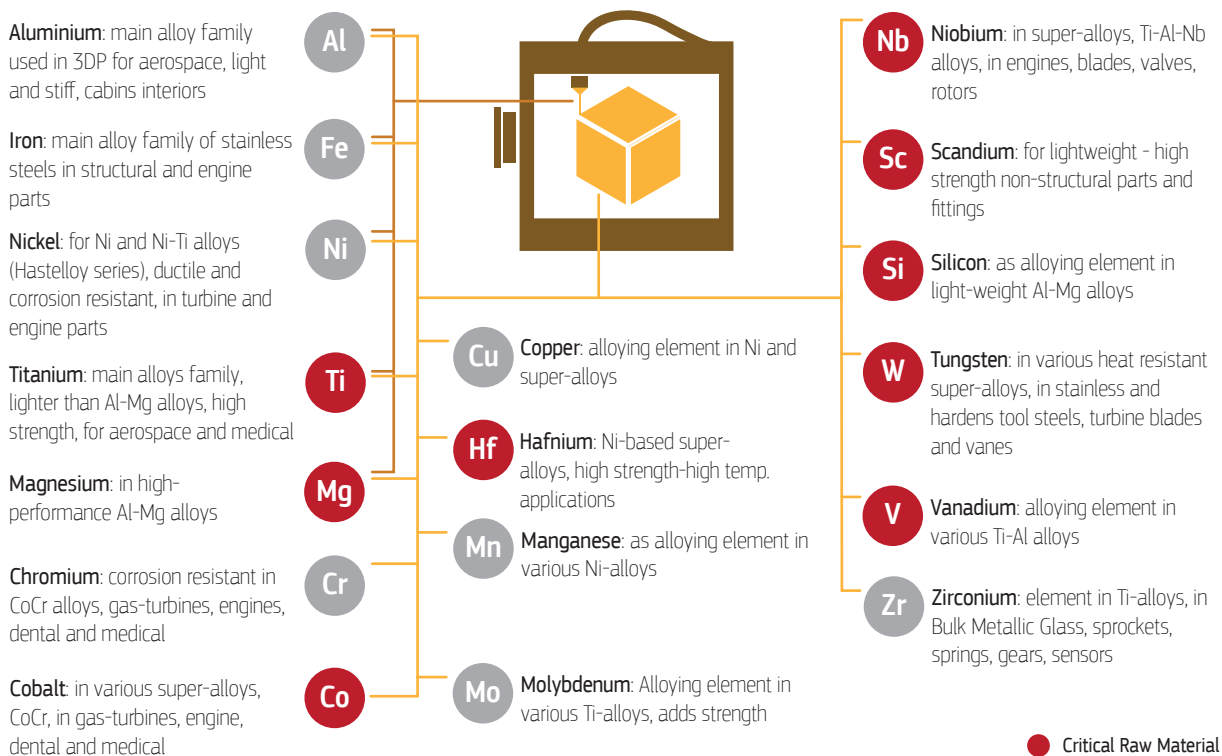

2.8.1 Current supply bottlenecks along the value chain

Figure 40. 3D printing: an overview of supply risks, bottlenecks and key players along the supply chain.

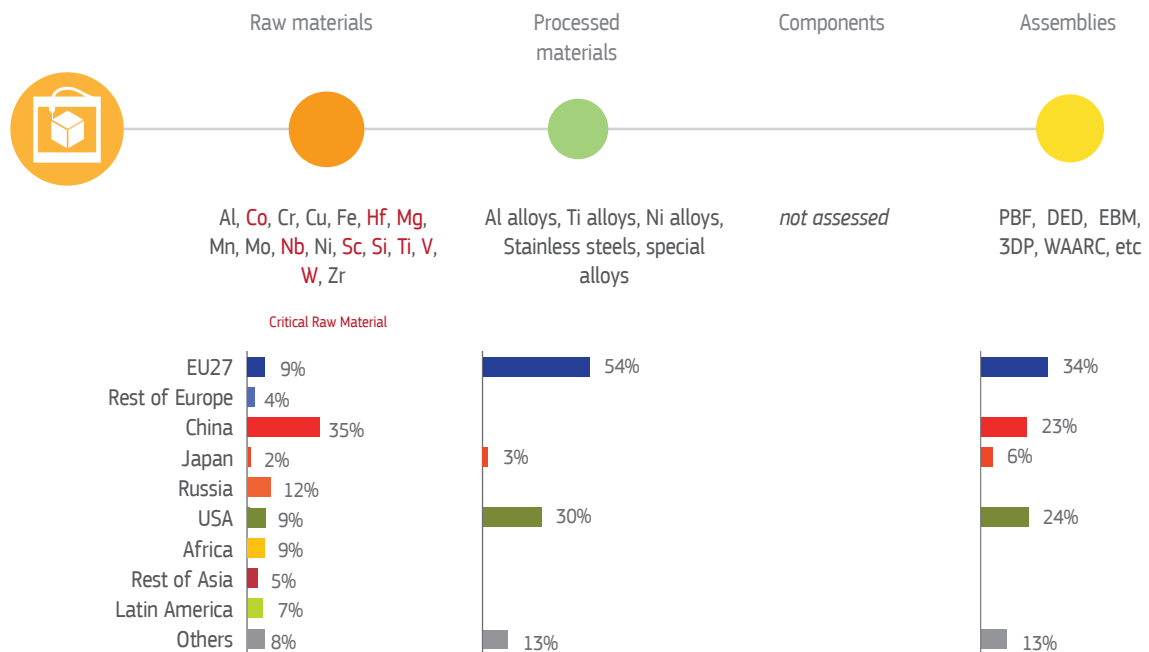

An overview of raw materials, processed materials and components required for this technology and the respective key supply countries is presented in Figure 40.

China is the major supplier of around 30% of the raw materials required in 3DP and the largest supplier for 7 out of 16 raw materials used in 3DP. 4 out of 7 CRMs identified for 3DP according to the EU 2017 CRM list, come from China (magnesium, vanadium, tungsten, scandium). Other key suppliers of CRMs are South Africa and Brazil. The supply of 3DP relevant CRMs from European countries is negligible (1%). Supply risks are particularly high for titanium, cobalt, magnesium, vanadium, tungsten and niobium. In addition, also there are significant risks for scandium, hafnium and zirconium for example in super-alloys for space applications.

The EU has strong metallurgical capabilities to deliver processed materials. This counts in particular for nickel alloys, stainless steels and special alloys. However, there is only a

small number of metal powder suppliers globally. Any supply disruptions in one of these early material production stages are likely to have immediate and severe impacts on the availability of a wide range of components.

The supply of components and assemblies is marked by a high level of concentration around key OEMs. For example, for the aerospace sector, 3DP suppliers and integrators such as Boeing and GE (US) are known for vertically steering and taking the lead on key developments. In the EU, Airbus is steering its supply chain more horizontally.

Historically, the EU is relatively well represented with about one third of the number of 3D printing system providers, including polymer systems. The EU has about 20% of market share for all commercial printer systems and the US and Israel represent over 71% of the supply. For manufacturers of metal 3DP machines only, the EU is well represented as illustrated in Figure 40. However, the R&D pace in the US and



China is much higher, thus threatening the innovative status of the EU whilst the technology is maturing very fast.

The main concern about the supply chain is the fact that most of the commercially used 3DP technologies are rigid in terms of input processing variables. Hence, it is difficult to customize powder compositions according to the end user needs. Lack of flexibility in recipes available for different machines impacts costs as well as quality and consistency of parts produced. Despite the strong position of the EU in processed materials

as well as in 3DP systems, further technology development directly depends on having access to quality raw materials. Here, mastering the most optimal combinations of processed material recipes versus the specific 3DP technology is the key to innovation. In other words: any raw material supply disruptions would immediately limit 3DP innovations in which the EU has a strong position.

2.8.2 2030/2050 perspectives of raw materials demand

At present, it is not possible to quantify the current and future demand for raw and processed materials on a quantitative basis. The only perspectives possible are based on economic market development sources like Statista (Statista, 2018)

and Boston Consulting Group (BCG, 2018). The BCG forecast is displayed in Figure 41. It shows an impressive growth rate with a Compound Annual Growth Rate (CAGR) of well over 20%.

Figure 41. Projected 3D printing market.

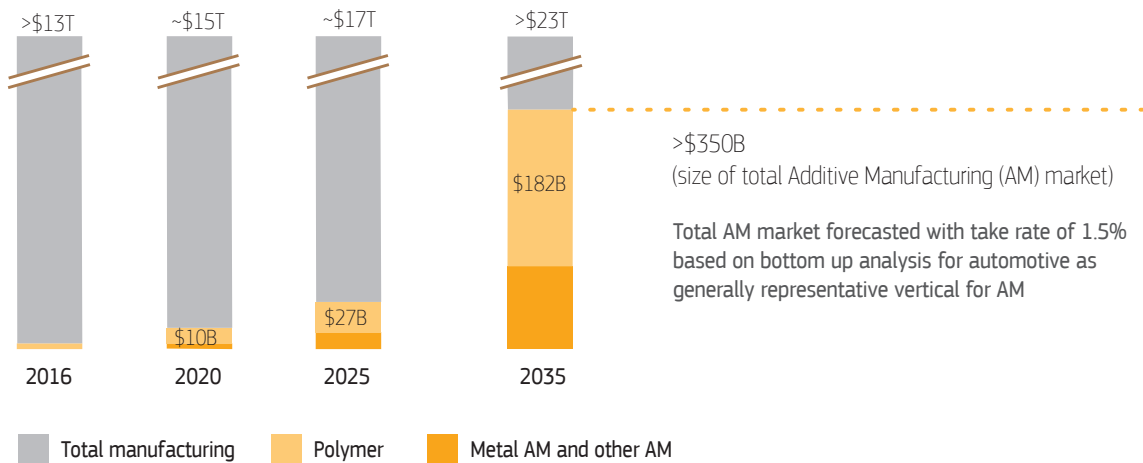

Source: adapted from (BCG, 2018).

2.8.3 Key observations and recommendations

The main advantages of 3D printing for various sectors are possibilities for reduction, substitution, recycling and mitigation in the use of raw materials and traditionally manufactured components. The additive manufacturing market is expected to grow substantially, with a CAGR of between 15% and more than 30% in the next few years. The aerospace, automotive, and medical industries will account for 51% of the 3D printing market by 2025. 3D printing in medical devices is expected to grow by 23% between 2015 and 2025, while for the aerospace and defence industries an annual growth rate of around 26% is expected.

The EU is shown to be the major supplier of the processed materials required in 3D printing technology, with around 54% supply share. It is followed by the USA (30%), Canada (9%), Japan (3%) and other smaller suppliers delivering the remaining 4%.

The bottleneck assessment shows a potential high risk to supply for one step of the supply chain: raw materials. No significant supply issues are to be expected for processed materials and moderate supply risk is perceived for 3D printing systems due to high demand expected in future. Relatively speaking, there are fewer bottlenecks identified compared to other technologies in this report. The EU has a relatively strong position in 3D printing, and especially in metal-based additive manufacturing for aerospace applications. At the same time, a high raw materials dependency exists, in particular for titanium and strategic minor elements used in special alloys, like scandium and niobium.

Mastering the quality of 3DP materials in relation to the specific 3DP technology, is a core element for maintaining EU competitiveness. It is recommended to organise a more centralised, strategic and comprehensive discussion on the role of the EU metal 3DP sector for Industry 4.0 development in relation to smart factories, robotics and other modernisation trends in manufacturing.

The following recommendations are made:

- ▶ *Diversifying the materials supply:* Diversification of supply and trade agreements is supporting a strong EU additive manufacturing sector. In particular efforts to secure the supply of titanium and strategic minor elements used in special alloys, like scandium and niobium deserves further attention.
- ▶ *Promote R&D, develop skills and competences:* Further R&D efforts are recommended, in particular for research towards aluminium–magnesium and titanium alloys where the EU is relatively weak. It is important for developing an attractive 3DP ecosystem in the EU to invest in R&D to master the relation between processed materials (metal powder recipes) and the various 3DP technologies.
- ▶ *Improve manufacturing opportunities in the EU:* The EU dependency on raw materials goes beyond physical access to the individual minerals. It is recommended to further analyse specific economic conditions related to mining conditions, ownership, trade restrictions, environmental permitting and other uneven conditions. Industries outside the EU are for example less concerned with responsible sourcing, potentially causing an uneven playing field. This is undermining social and environmental conditions in developing countries. Securing sustainable access to the right quantity and quality of raw materials will be key for future responsible EU industry developments. Targeted investment in 3DP R&D will enhance capabilities related to mobility, sustainability, repair and maintenance. More investment is needed to keep up with the pace of development in the USA and China.
- ▶ *Foster international collaboration and standardisation activities:* There is a clear need for standardisation of metal AM powders and metal wire on the one hand, and the quality and reproducibility of parts on the other. This applies to aerospace in particular, with strict safety and performance requirements. The standardisation and certification of metal powders and wire recipes for 3DP, which would aid EU companies in particular, considering that EU companies, and SMEs in particular, are relatively well positioned to produce high-quality components (Duchêne et al., 2016).
- ▶ *Recycling and reuse, substitution:* It is advised to further analyse the possibilities for recycling of 3DP components as well as the recycling of powders not consumed in manufacturing. In particular the presence of more exotic components requires attention.



2.9 Digital technologies

2.9.1 Current supply issues along the value chain and future trends

Digital technologies are transforming the world at an unprecedented speed, and they have changed how we communicate, live and work. The EU will strive to achieve the technological sovereignty in some critical digital technology areas (e.g. blockchain, quantum computing and data sharing). Digitisation and digitalisation will transversally affect all the various technologies and sectors explored in this report as they increase productivity and efficiency of the industry and enable more customised and diversified product portfolios (EC, 2017). Through “Internet of Things” (IoT), connected robots, autonomous vehicles and sensors will be more and more integrated in industrial processes, common goods and services, across the value chains (see Figure 42).

Whereas the criticality of materials applies to the wider European industry landscape, many CRMs are particularly essential for information and communication technology (ICT) devices and advanced electronics. Europe’s reliance on foreign digital components and technology is increasing as it falls behind on the production of key digital technologies. In 2017, the EU’s overall trade deficit for high-tech components and products stood at €23 billion – largely due to sizeable Chinese imports (European Political Strategy Centre, 2019).

From the raw material perspective, the digital ICT industry has three main features (Ku, 2018). First, it uses a wide and increasing range of elements to enable the desired electronic, magnetic, optical, or mechanical properties needed for chips and devices. Second, the large number of chips and devices

that are produced each year suggest that even incremental uses in certain elements can amount to meaningful volumes of material relative to current supply. Third, the speed of technology introduction cycles can be faster than the time scales associated with other aspects of the supply chain.

Other raw materials that are not used in ICT equipment are equally relevant to ensure its proper functioning and may become critical for the deployment of next generation computing. For example, helium is used to create the low operating temperature close to absolute zero that is needed for quantum computing technologies, supra- and semiconductors.

One of the main consequence of digitalization will be the enormous amount of data produced and stored in data centres, enterprise infrastructures and endpoints (such as PCs, smart phones, and IoT devices). The summation of all these data is called the “global datasphere” and is experiencing tremendous growth. The International Data Corporation predicts that the global datasphere will grow from 33 Zettabytes (ZB) in 2018 to 175 ZB by 2025 (Reinsel, Gantz, & Rydning, 2018). The increased data need will have a big impact on technologies for data storage, including the additional demand of materials for memories production (see Figure 43). Based on (Ku, 2018), it can be estimated that the storage of the expected 2025 global datasphere would require up to 80 kilotonnes of neodymium, about 120 times the current yearly EU demand of this material. Using instead emerging technologies such as ferroelectric RAM would require up to 40 kilotonnes of platinum, which is about 600 times the currently yearly demand of the EU.

Figure 42. Digitalisation and sustainable production and consumption.

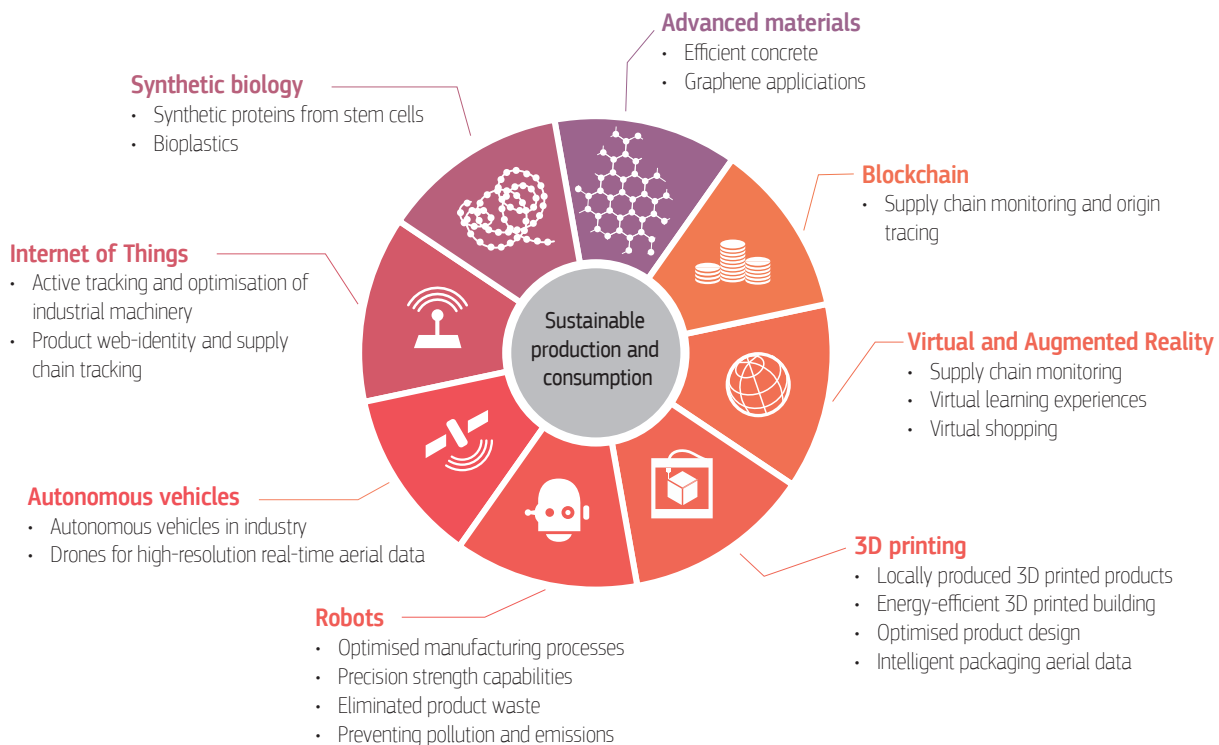

Source: adapted (PwC, 2017a).

Figure 43. Estimated materials intensity factors for different memory technologies. Amounts are in tonnes per Zetta-byte.

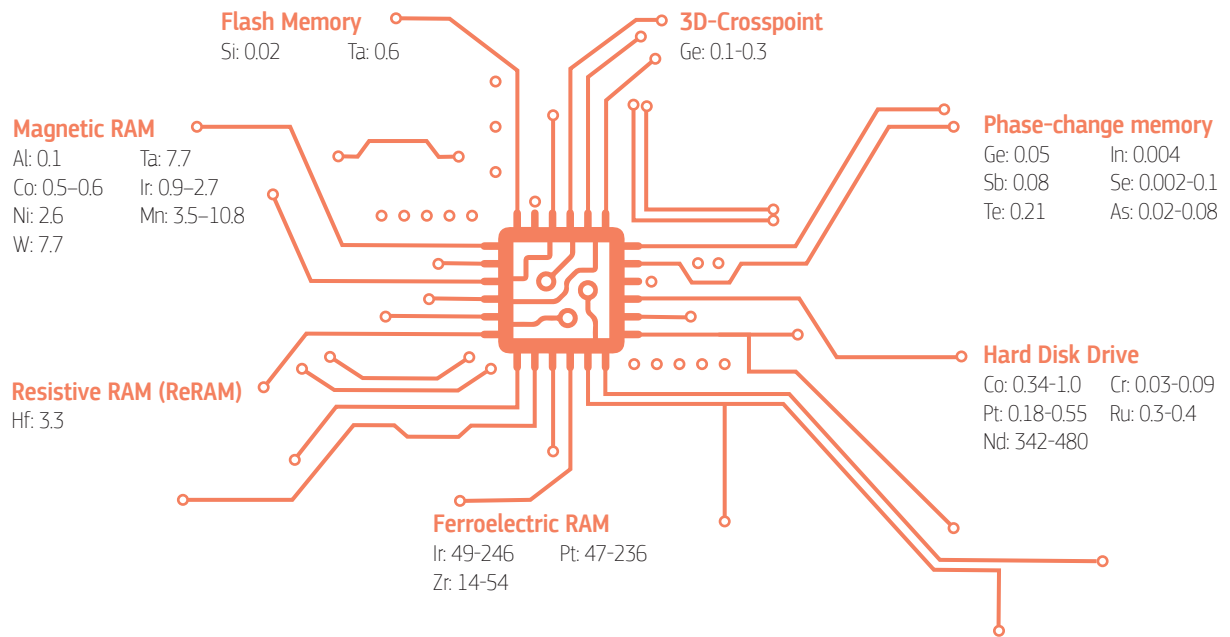

Source: adapted from (Ku, 2018).

The global expansion of digital networks and services implies that more people have access to the internet, thus fuelling the need for connected equipment and fibre optics that the EU could produce and export. Important influencing factors for future trends include miniaturization of components, measures against planned obsolescence and restrictions on exports of e-waste. In addition, the search for more performant and cheaper materials or components of electronic appliances fosters substitution, making future demands more unpredictable in the sector. The demand of CRMs in this sector could indeed either level off or keep increasing (REEs, tantalum, palladium for electronic devices & appliances; ermanium for optic fibres) (Tercero, 2019).

Digitalisation will be also accompanied by the progression in sales of ICT devices, mainly smartphones, which are expected to grow steadily from 130 million units sold in 2018 up to 180 million in 2035 (Monnet & Ait Abderrahim, 2018). Laptop and desktop computers sales are estimated to remain roughly constant. Table 2 shows the content of some CRMs in ICT devices and how these quantities are expected to grow in future: the table also includes the ratio of CRMs used for ICT devices (in 2015 and 2035) compared to the current EU consumption. Demand trends and their significance are quite different from one CRM to another. Despite the growth in sales for some electronic devices, the expected use of related CRMs would either stagnate or rise in relatively limited proportions (palladium, gallium, dysprosium, neodymium). The case of tantalum for which electronics is currently the main application is interesting: tantalum's use in electronic applications alone could outpace the current use of this material, all applications factored together.

Similarly, development of digital technologies and in particular of electronic displays (including flat screens and touch

screens) has boosted the consumption of indium used in indium-tin-oxide (ITO) thin-films. In the past, indium experienced a more than fivefold growth in (primary) production between 1993 and 2013 (Tercero, 2019). Indium is among the elements capturing a growing consideration due to its relatively high economic importance, lack of substitutes, extraction as a by-product from carrier metal ores, low recovery efficiency of processing, and non-existent recycling at end of life (Ciacci et al, 2019).

Trends presented above consider a rather conservative and technology-constant approach of digitalisation. Other authors argue that a much larger increase of consumption of those materials in the future is to be expected due to upgrade of production infrastructure and large consumption of new devices, including sensors and actuators (Bonilla et al, 2018). Supply risks might also be impacted by the fact that recycling potential of CRMs from ICT technologies will be largely limited or not feasible in the near future (Marscheider-Weidemann et al, 2016).

ICT technologies can also act as enabler for a more efficient use of scarce metals, e.g. supporting the management and monitoring of increasingly complex (reverse-)supply chains (e.g. improving traceability) and as new technologies in support to recycling (Widmer & Wäger, 2013). Finally, the development of the digitalisation can disclose novel security risks. In a world with ubiquitous connectivity between all things, vulnerabilities will increase exponentially. As sensors, algorithms and data flows become an integral part of our lives, citizens' distrust in technologies stems overwhelmingly from security concerns (European Political Strategy Centre, 2019). Such data privacy and security issues could have in future an



impact even on the material efficiency and circularity of ICT products (Polverini et al., 2018), hence preventing the development of reuse and recycling as valid resource efficiency options.

Figure 44 summarises the main raw materials adopted for digital technologies and their functionality, while an overview of key players is presented in Figure 45.

Table 2. CRM significance indicators for smartphones, laptops and desktop PCs.

CRM	A. Use in 2015 (t)	B. EU apparent consumption (t)	% (A/B)	C. Use in 2035 (t)	% (C/B)	Notes
Pd	7	60	12%	10	17%	The use of palladium in electronics is related to the production of some printed circuit boards and in multi-layered ceramic capacitors (in mobile phones)
Ga	4	80	5%	5	6%	The main use of gallium in electronics is in semiconductors for Integrated Circuits. In particular, Ga is used in Power Amplifiers (PAs) used in cell phones to amplify signals, both voice and data. The more advanced the generation used (3G, 4G, 5G), the more PAs needed.
Ta	80	100	80%	110	110%	The main application of tantalum is in special capacitors, characterised by high capacitance, small size and high performance. Thin layers of tantalum are also used in integrated circuits.
Nd	90	1 000	9%	120	12%	The main application of neodymium is for NdFeB permanent magnets used in hard drives
Dy	9	180	5%	12	7%	The main use of dysprosium is in NdFeB permanent magnets to increase the resistance of the magnet to high temperatures

Source: Adapted from (Deloitte Sustainability, British Geological Survey, Bureau de Recherches Geologiques et Minieres, and Netherlands Organisation for Applied Scientific Research, 2017) and (Monnet and Ait Abderrahim, 2018)

Figure 44. Raw materials in digital technologies.

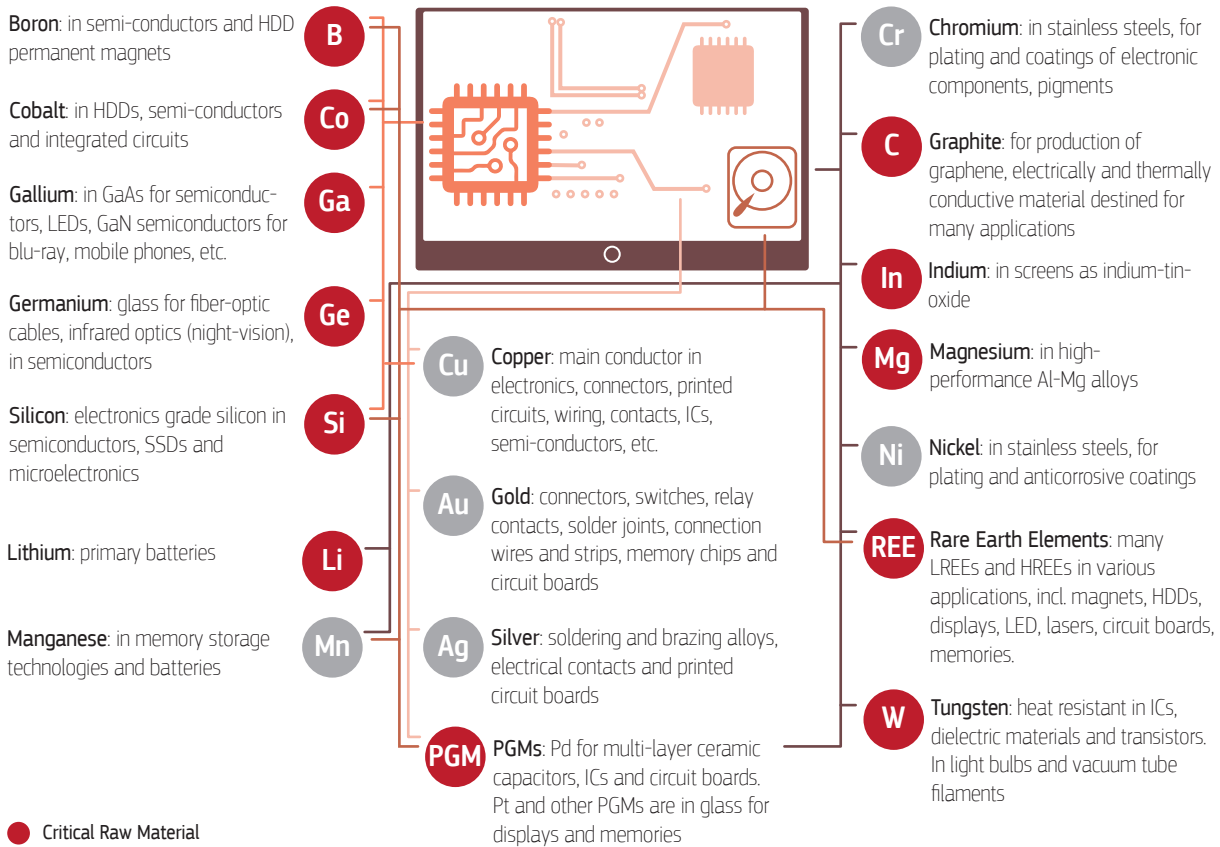

Source: (BCG, 2018).

Figure 45. Digital technologies: an overview of key players along the supply chain (assessed for raw materials only).

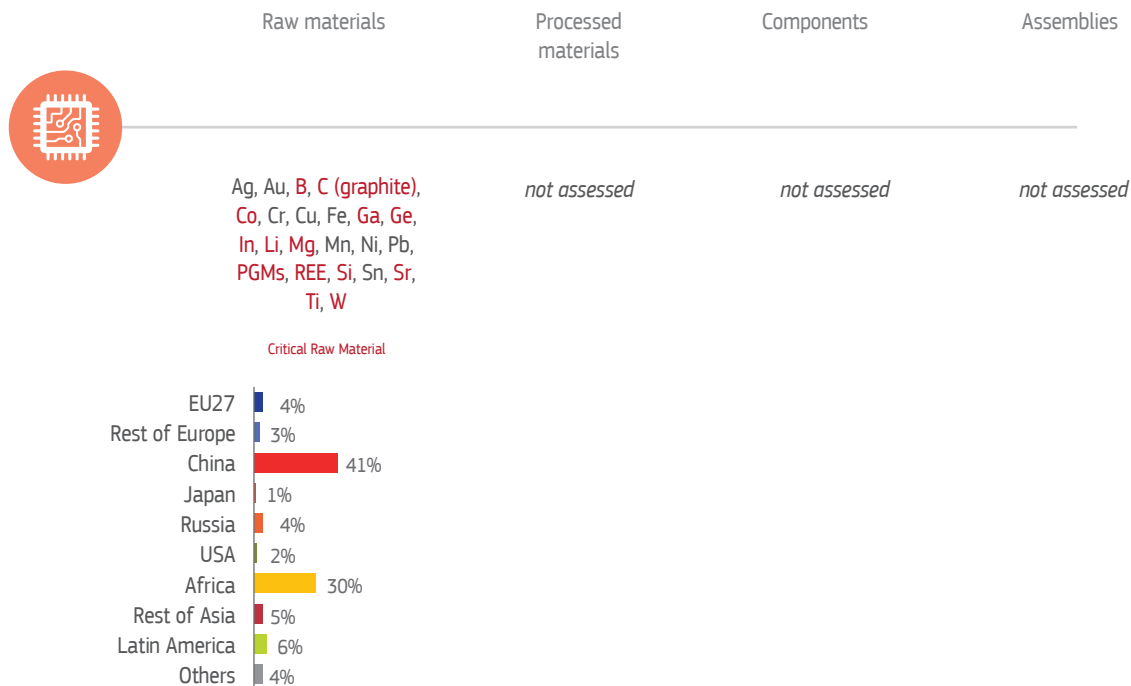

2.9.2 Key observations and recommendations

Digital technologies are strategic technologies that do not only sustain the enormous digital sector but are also enabling technologies for all the sectors and technologies discussed in this study;

Developing quantitative forecasts for future development of these digital technologies and contained raw materials was beyond the scope of this study and will require further work. However, semi-quantitative analysis shows that increased EU consumption of some CRMs (e.g. palladium, gallium, dysprosium and neodymium) for these technologies is likely to happen;

It is premature to establish detailed observations and recommendations in the absence of a structured bottlenecks analysis, like for the other technologies. Still, the EU appears to be largely dependent on other countries (mainly South-East Asia) for high-tech components and assemblies. Obviously if the EU wants to be fit for the Digital Age and achieve technological sovereignty in some critical technology areas, it will have to strongly develop manufacturing opportunities for components and assemblies. A prerequisite for this digital re-industrialisation will be to secure the access to key raw materials that are essential to these technologies (for example REEs, gallium, germanium and PGMs) and develop capabilities on processed materials;

The leading role of the EU concerning collection and management of Waste Electric and Electronic Equipment and in standardisation (also concerning material efficiency of electr(on)ic equipments) could also be an asset to reduce supply risk of raw materials for digital technologies.

3 Critical raw materials for strategic sectors



3.1 Renewable energy

The transition towards a low-carbon society will come with a large-scale deployment of renewable technologies such as wind and solar PV. By 2050, more than 80% of electricity pro-

duced in the EU is expected to come from renewable energy sources, with electricity providing for half of the final energy demand in the EU, see Figure 46 (EC, 2018).

Figure 46. Gross inland consumption of energy in the EU for various timelines and scenarios

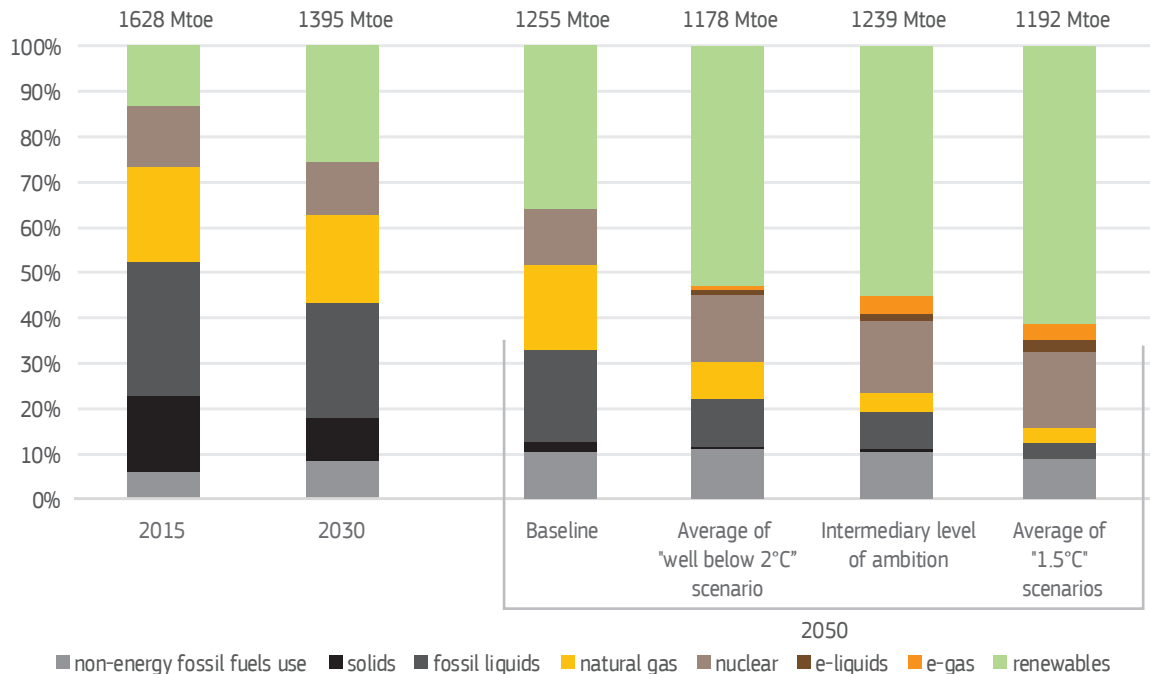

Source: (EC, 2018).

3.1.1 Relevant technologies

Many technologies are used to convert the renewable resources into electricity (e.g. wind turbines and solar panels), store this energy (e.g. in rechargeable batteries), improve the manufacturing processes (e.g. through robotics and 3DP) and facilitate the conversion and transmission of the electricity via smart grids (e.g. using digital technologies).

Wind power is one of the fastest growing renewable technologies and together with solar PV has the potential to provide a significant amount of our electricity. More utilities and companies are expected to invest in solar and wind farms, including wind turbines located in the sea area as offshore wind.

Considering the 'intermittent' characteristic of wind and sun as energy sources, storage technologies, such as the newer large-scale Li-ion batteries and fuel cells, are critical components for creating a low-carbon electricity system. They allow the production of low carbon electricity when possible and save it for later use.

Hydrogen can be an important part of the clean energy mix, boosting renewable electricity market growth and broadening the reach of renewable solutions. Although a hydrogen-based energy transition will not happen overnight, it is essential that the EU continues its policy and business effort to ensure a significant share of hydrogen in the energy systems. Obvious-

ly, green hydrogen will have to be produced from renewable energy; today it is produced from natural gas.

Digitalisation, innovation in robotics and additive manufacturing will contribute to the acceleration of the renewable energy sector. Digitalisation is key enabler of the transition to clean energy through improving the safety, productivity, accessibility and sustainability of energy systems, for instance by facilitating grid management and operation. Robots and automation are expected to increase their share in the production of renewable energy generators, enabling industry to save time, increase productivity and optimise performance. For example, robotic automation is already used in solar systems for manufacturing silicon ingot, silicon modules, solar cells and silicon wafer and in wind turbines for welding certain structural components, in sharpening the edges of gears and handling the turbine blades. Despite still higher manufacturing costs than for the conventional ways, 3D printing has already proven its capability to efficiently produce renewable energy products, e.g. by creating large components for the offshore wind turbines.

Figure 47 shows the relevant raw materials and technologies for the renewable sector.



Figure 47. Materials and technologies relevant to the renewable energy sector

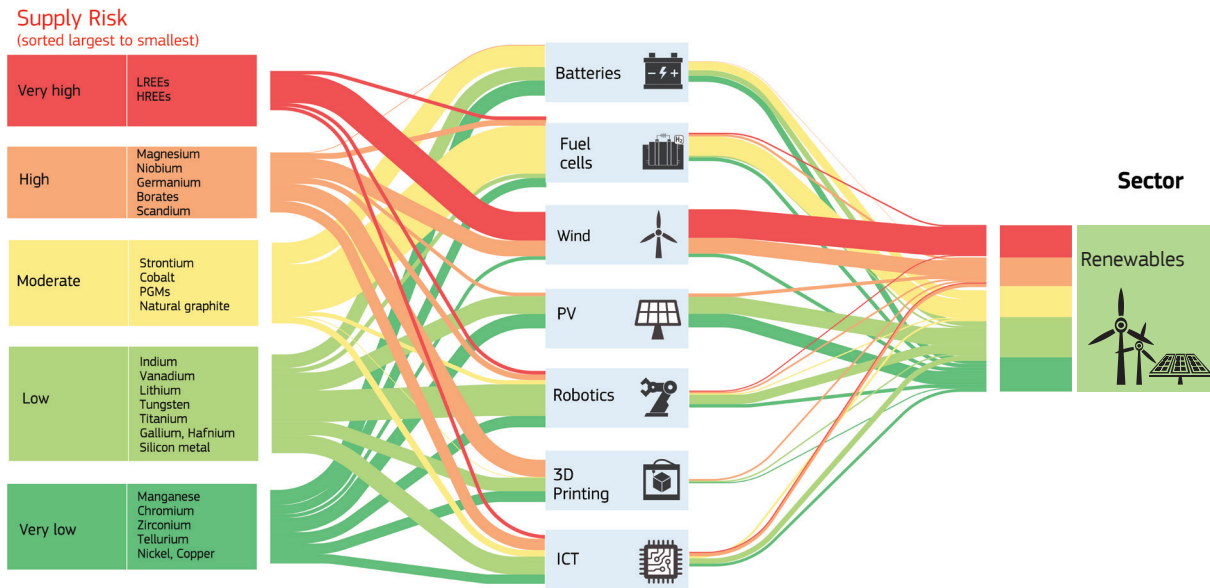

3.1.2 Raw materials relevant to renewable energy sector and supply bottlenecks

The shift to low-carbon energy systems will imply massive changes in the raw materials requirements, due to the deployment of the technologies described above. For example, some critical REEs such as neodymium, dysprosium and praseodymium, are key ingredients of permanent magnets used in high-performance wind turbines. CRMs such as borates, gallium, germanium, indium and silicon metal are needed in

solar PV, robotics and digital technologies. Batteries employ CRMs such as cobalt and natural graphite, which are also required in 3DP and digital technologies. Platinum is used as a catalyst in FCs and in digital applications, for example for hard disk drives. Overall, the renewable sector requires many raw materials ranging from very high to low supply risk with the split among technologies as shown in Figure 47.

Figure 48. List of critical and non-critical raw materials used for renewables ranked by their 2020 supply risk

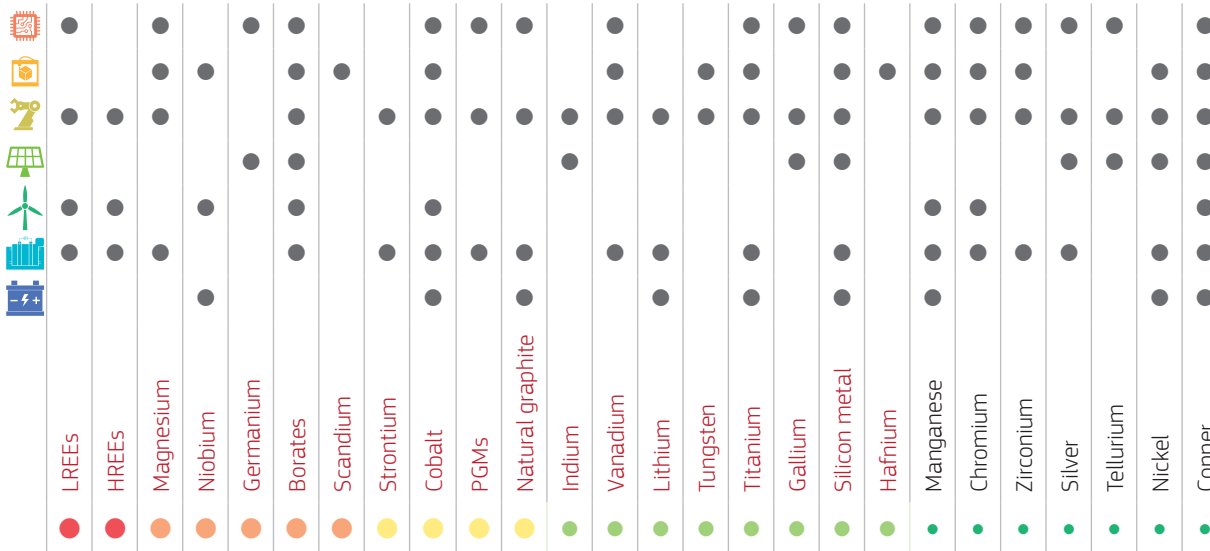

The potential supply bottlenecks of materials use in technologies relevant to the renewable energy sector are presented in Figure 49. The raw materials stage is a concern for all technologies, except for solar PV. Technologies for ESS – batteries

and FCs – are very vulnerable at the stage of assembly. The most vulnerable step at the level of components is for solar power.

Figure 49. Supply bottlenecks for seven technologies relevant to the renewable sector

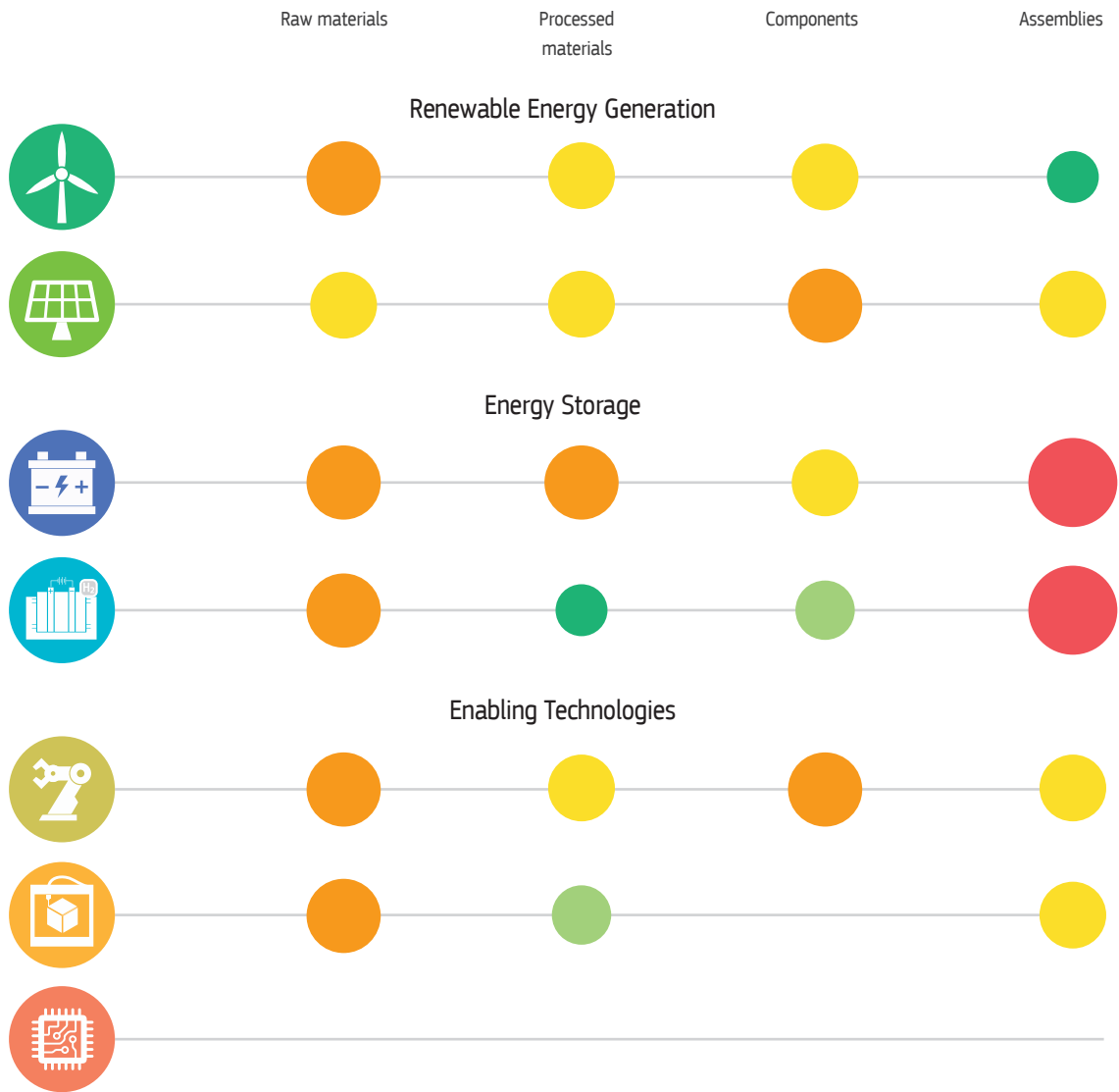



3.1.3 Projection of future materials demand

Scenarios described in Section 2 project a comparable expansion of wind and PV power plants. For both of them, the EU installed capacity in 2050 is in the order of 500 GW in LDS, 1 000 GW in MDS, and 2 000-2 500 GW in HDS. As the assumed lifetime is similar (offshore turbines are deemed to have a slightly longer lifetime than onshore turbines and PV panels), which implies similar annual replacement rates, the main differences in material demand depend on the material intensity.

Wind and PV have a common group of general materials adopted for construction and electric connections. These are essentially concrete, steel, plastics, glass, aluminium, and copper. Wind turbines are bigger and heavier than PV panels, hence they require massive foundations, which results in higher concrete demand. In particular, one MW of wind requires in between 250 to 400 tonnes of concrete, while no more than 60 tonnes are needed for each megawatt of solar PV. Wind demand is also higher for steel (some 100 t/MW

Figure 50. EU annual material demand for renewables in 2030 and 2050

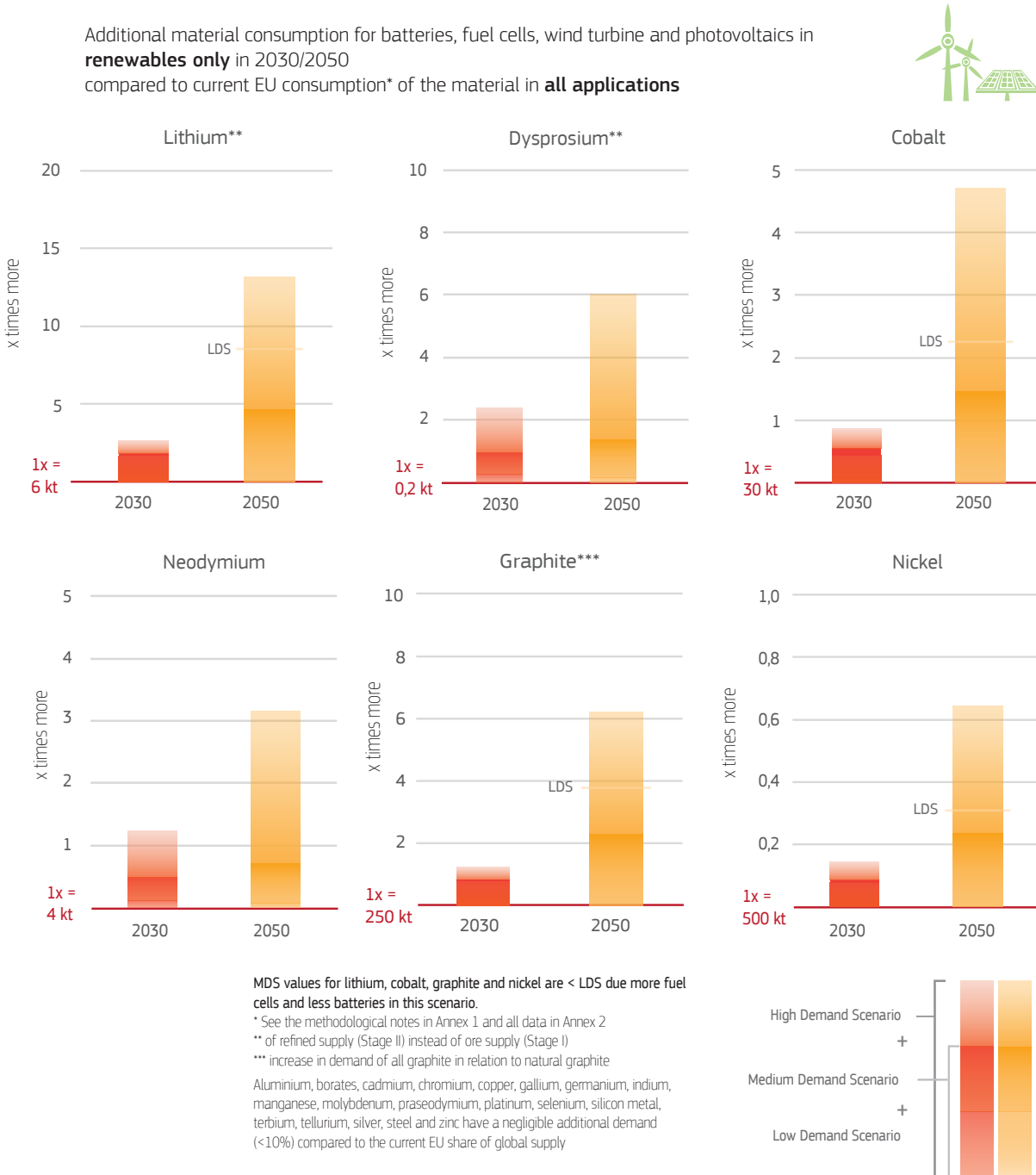

against 70 t/MW in the case of PV panels). Material intensity is instead higher for PV as far as glass (some 50 t/MW against 8 t/MW) and aluminium (8 t/MW against 1 t/MW) are concerned. Finally, plastics (5-6 t/MW) and copper (5 t/MW) show similar intensity.

Specific materials are borates, dysprosium, molybdenum, terbium and yttrium for wind (mostly used in PMs) and cadmi-

um, gallium, germanium, indium, selenium, silicon metal and tellurium used for solar PV panels. Other general construction materials are chromium, iron (cast), manganese, nickel and zinc, which are relevant for wind only. Figure 50 shows the relative demand increase in 2030 and 2050 for selected materials compared to current EU consumption.

3.1.4 Key observations and recommendations

A renewable energy system is more than just renewable electricity production; it also requires technologies for energy storage, new infrastructure, automation and smart/digital technologies.

The EU is dependent on imports of many of the raw materials used in these technologies and is susceptible to supply interruption for materials characterised by high and very high supply risk such as REEs, magnesium, niobium, germanium, borates and scandium. For some of these raw materials the EU lacks domestic primary production.

Based on the long-term decarbonisation scenarios for the scale-up production of the renewable generation technologies such as wind and solar PV, the demand for several materials will increase significantly by 2050. EU demand for the raw materials used in wind turbines, in particular REEs in PMs, is expected to increase by up to six times in 2030 and up to 15 times in 2050 in addition to current EU consumption in the most severe scenario.

When looking at the supply chain, the raw materials step is the most vulnerable for most technologies used in renewable sector, in particular for energy storage and enabling technologies (e.g. robotics and 3DP). This is followed by the assembly step, in particular for the energy storage technologies, and the components step. The EU appears less susceptible to supply bottlenecks for processing materials, although there are significant gaps as in the case of processed materials used in battery applications.

Several mitigation measures should be put forward by the EU to improving the materials supply chain and the EU's industrial competitiveness of renewable technologies such as: diversifying the materials supply, promoting research and innovation, sustaining the long-term investments for new mining and refining activities, boosting recycling business and strengthening downstream manufacturing in the EU. Among these measures, R&D efforts to reduce materials use through substitution and increased materials efficiencies will allow the industry to produce and store more renewable energy with less raw materials. Logistic, technological and knowledge efforts will be necessary in the sector to enhance reuse of components and improve collection and recycling of technologies to produce high quality secondary raw materials.

However, improvements in materials efficiency and recycling rates will not be sufficient to cover completely the future demand of the sector. The EU should hence make use of its mineral reserves and look at technological solutions for developing a primary sourcing while tackling the social and environmental hurdles.



3.2 E-mobility

The increasing role of e-mobility in the future of road transport in the EU requires the deployment of multiple new technologies. According to JRC (2019b) 'a storm of new technologies and business models is transforming everything about how we get around and how we live our lives'. Figure 51 below illustrates the evolution of vehicles technologies forecasted from 2015 until 2050 (Hill et al., 2019). The uncertainty of the development of new technologies in the e-mobility sector is still very high. For example for FCEVs, several scenarios co-exist as reflected in (Harrison and Thiel, 2017): long-term

emission targets, when effectively implemented, can significantly shift to a much higher uptake of FCEVs. Below illustrates the evolution of vehicles technologies forecasted from 2015 until 2050 (Hill et al., 2019). The uncertainty of the development of new technologies in the e-mobility sector is still very high. For example for FCEVs, several scenarios co-exist as reflected in (Harrison and Thiel, 2017): long-term emission targets, when effectively implemented, can significantly shift to a much higher uptake of FCEVs.

Figure 51. Forecasts of vehicles technologies diffusion in the EU 2015-2050

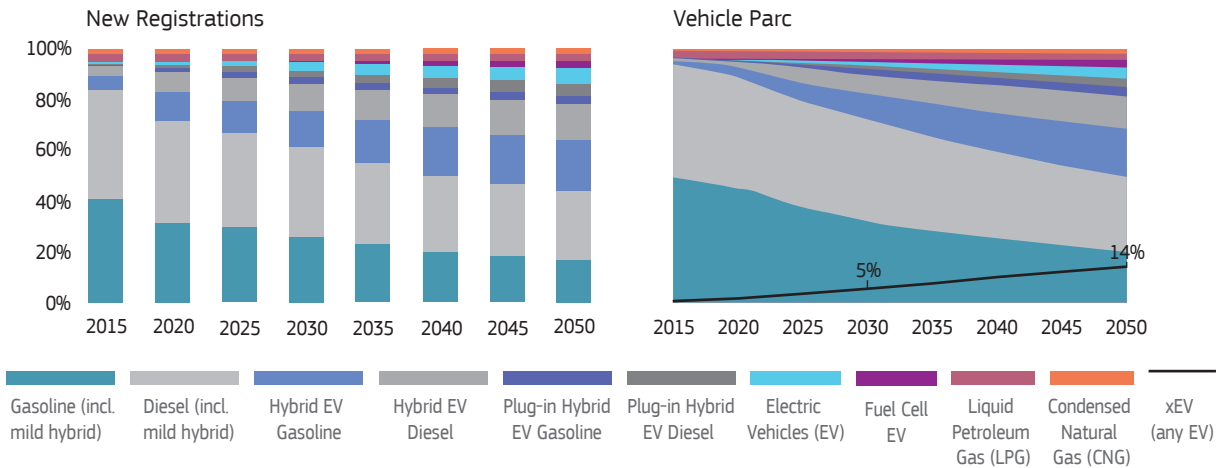

3.2.1 Relevant technologies

To enable the change to cleaner, automated, connected and low-carbon mobility, a large range of technologies is to be further developed: batteries, fuel cells, traction motors and ICT technologies will feed the deployment of e-mobility towards 2050 (Figure 52). At the same time, substantial changes in underlying manufacturing processes are foreseen as

well. Improvements in (manufacturing) robotics as well as 3D printing of lightweight and high-strength components drive the evolutions. Both developments are potentially altering the traditional manufacturing base in a disruptive way. In addition, digital technologies play a crucial role in increasing efficiency of manufacturing systems.

Figure 52. Relevant materials and technologies to the e-mobility sector

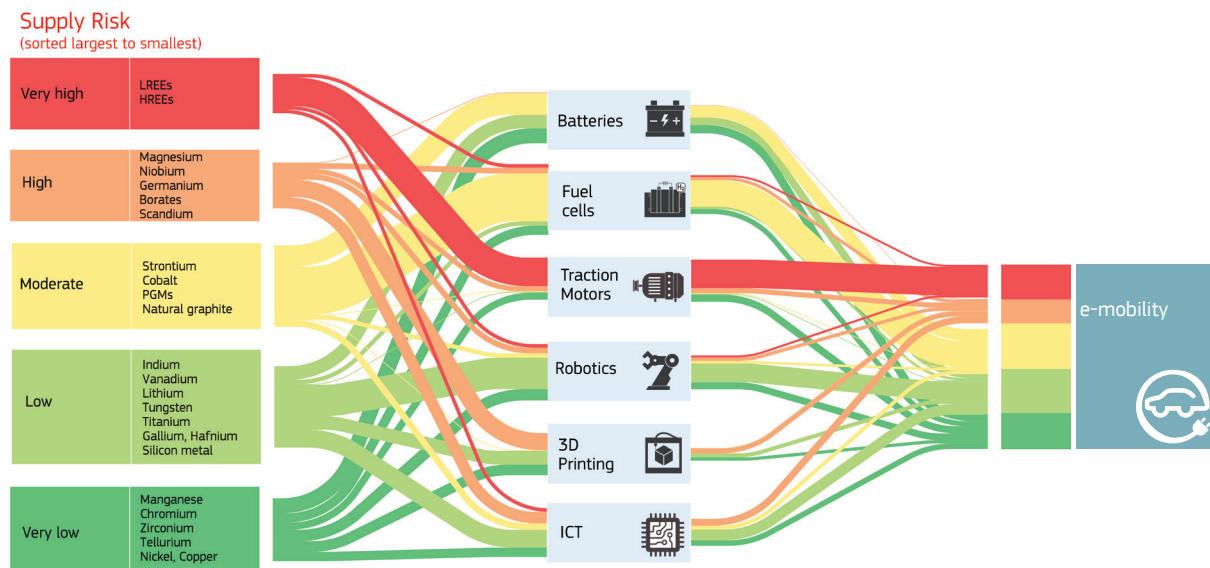

3.2.2 Raw materials in e-mobility and supply bottlenecks

The deployment of many technologies supporting the e-mobility sector will greatly impact the demand for materials in the future. In particular, REEs (neodymium, dysprosium and praseodymium) and boron are likely to be in a large majority of motors in EVs. Mobile energy storage will require CRMs such as lithium, cobalt and natural graphite in Li-ion batteries and platinum in FCs. Structural parts and lightweight structure of vehicles will require materials such as magnesium, niobium, silicon metal and titanium. As vehicles become increasingly

more electronic, they will consume gallium, germanium and indium in for example sensors, displays, circuitry, etc. Other alloying elements like chromium, tungsten and vanadium are in demand by almost all technologies (Figure 53).

Further upstream in the supply chains, other bottlenecks are identified, as displayed in Figure 54. Supply risk of the raw materials step for all technologies is a concern. The most acute bottlenecks concern once again the assembly step for Li-ion batteries and FCs.

Figure 53. List of materials used in e-mobility with their 2020 supply risk

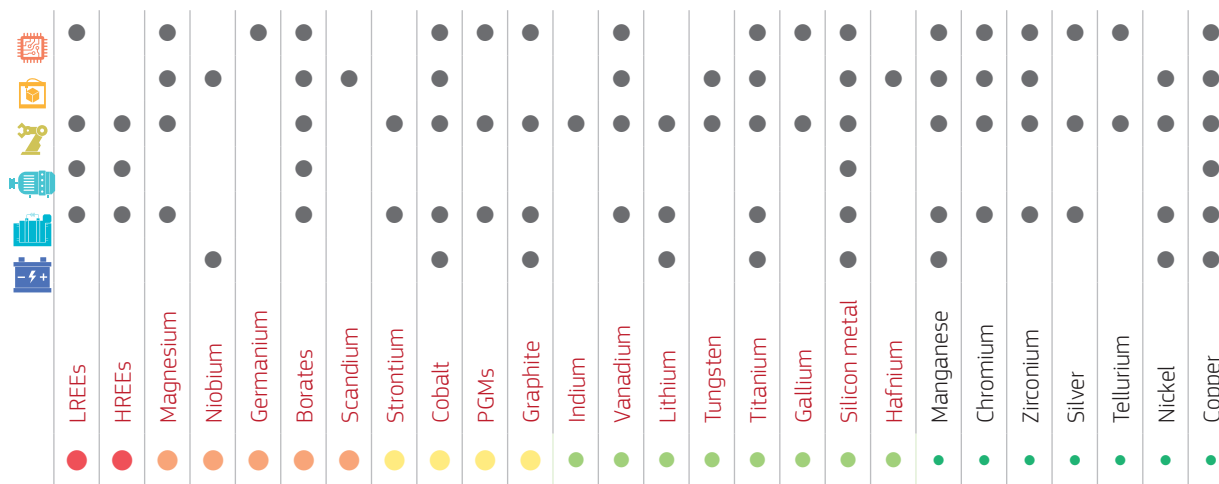
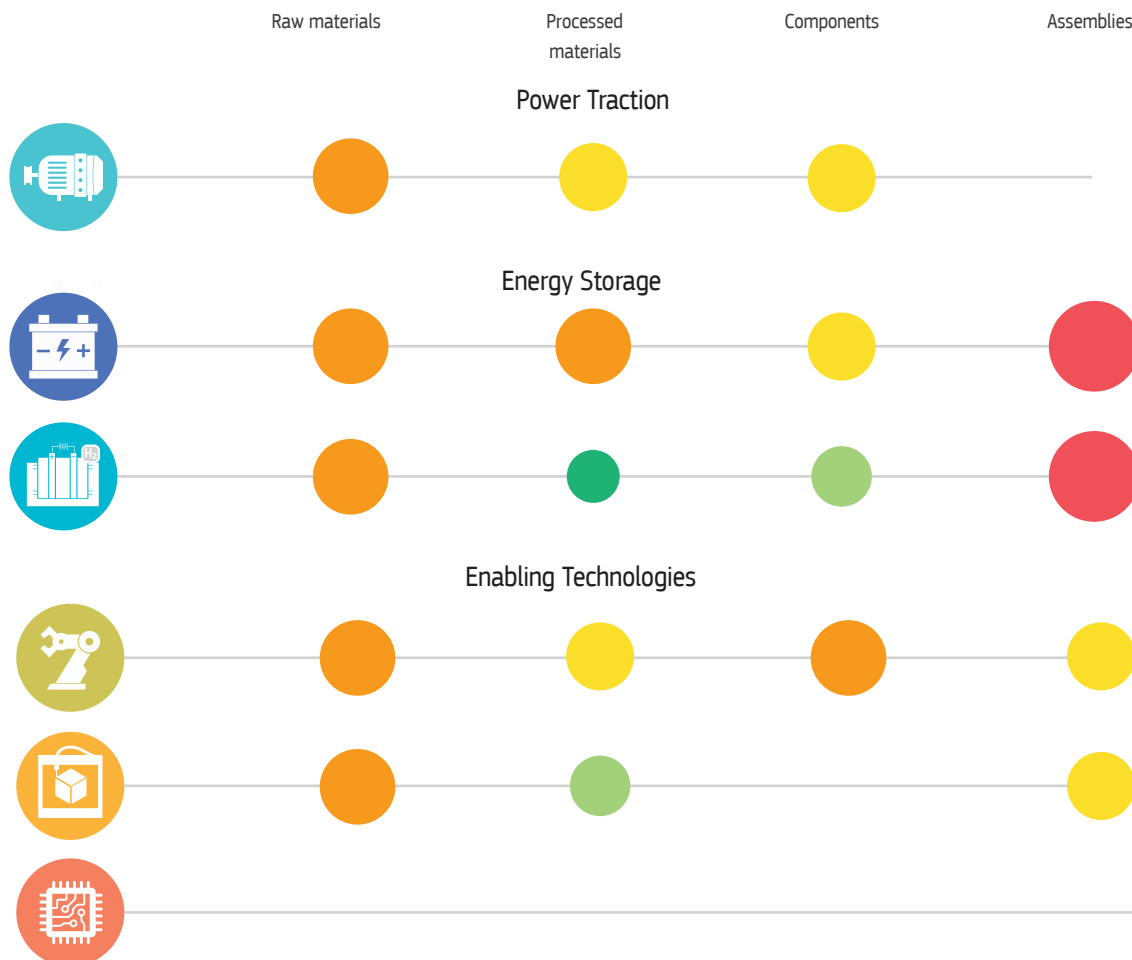

Figure 54. Potential supply risks in the value chains of emerging technologies relevant to the EU e-mobility sector: Li-ion batteries, fuel cells and traction motors





3.2.3 Projection of future materials demand

In Chapter 2, expected 2030 and 2050 fleets of EVs (including full, hybrid and FCEVs) in the EU were computed. In 2050, the fleet could reach more than 250 million vehicles in HDS and MDS and 150 million vehicles in LDS. Figure 55 presents EU annual consumption of materials for e-mobility sector based on these figures. Demand for lithium, graphite, cobalt and rare earths elements will increase dramatically.

Note that platinum is embedded both in FCEVs and in catalytic converters of conventional vehicles and PHEVs. Interestingly, considering a decrease of conventional vehicles in all the considered scenarios, platinum demand in 2050 in catalytic converters will occur only for the LDS scenario, as for the other two scenarios there will be no PHEVs and conventional vehicles placed on the EU market (see figure 17).

Figure 55. EU annual material demand for e-mobility sector in 2030 and 2050

Additional material consumption for batteries, traction motors and fuel cells in e-mobility **only** in 2030/2050 compared to current EU consumption* of the material in **all applications**

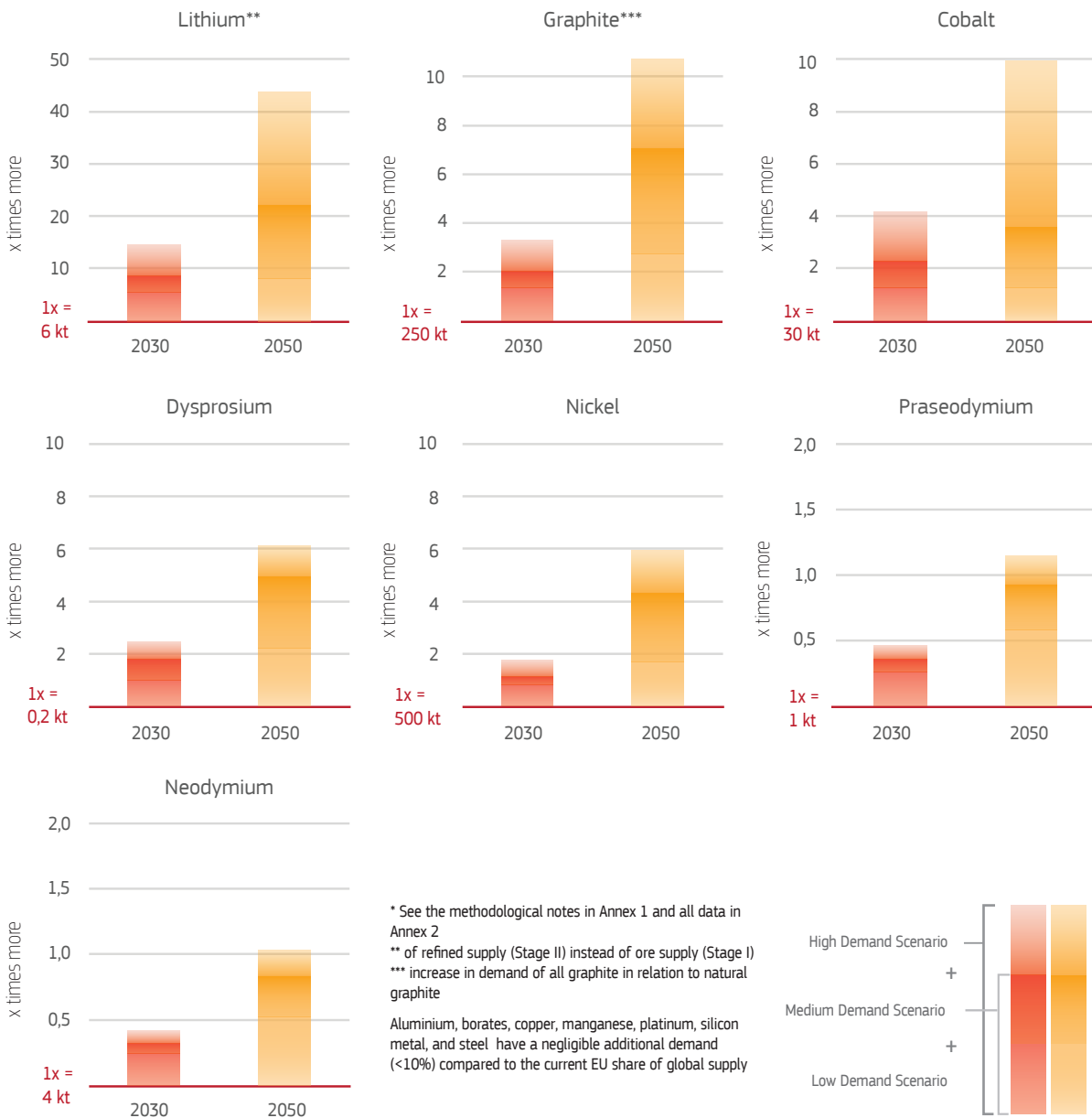

3.2.4 Key observations and recommendations

Technologies for e-mobility are currently under development, and their demand is expected to continue growing until 2050, with a consequent increase of the demand of typical (critical) raw materials and key components. For instance, in 2050, the EU demand for lithium will be 10-50 times higher than the EU 2018 demand in all applications, depending on the considered uptake of EVs and FCEVs. Similarly, the EU REEs demand in 2050 is expected to be 5-10 times higher than their demand in 2018.

The EU is highly dependent on imports of several raw materials that are keys for the development of e-mobility, and some of these materials have a very high and high supply risk (e.g. REEs, PGMs, cobalt and natural graphite).

Focusing on the supply chain, the most vulnerable steps are the raw materials and the assembly stages. China, Africa and Latin America provide the majority of raw materials required for the e-mobility sector. China is also the major supplier of batteries components (i.e. cathode, anode, Li-ion cells) and, together with Japan, dominates the production of permanent magnets and traction motors. In addition, fuel cells are mainly imported from the US and Asia. The EU is less vulnerable for processing materials, e.g. platinum for FCEVs.

Although end-of-life collection of vehicles is rather well organised in the EU, recycling as source of secondary materials at industrial level is not yet developed enough to consistently answer the market demand and further effort will be needed in the area, also to avoid collection and recycling leakages.

Even though mitigation measures to increase EU independence should be strengthened, the EU has already adopted measures, such as: trade agreements and R&D partnerships in various steps of the value chains (e.g. mining of REEs, diver-

sification of suppliers, substitution of materials), investments in domestic production of key components for e-mobility (e.g. European Battery Alliance), improvement of end-of-life strategies, definition of standards for components/products design, the extension the lifetime of key components (such as traction motors). Overall, circular strategies allow boosting materials efficiency, maximising the value along the whole value chain.

3.3 Defence and aerospace

3.3.1 Military applications and emerging technologies relevant to the European defence sector

The EU defence industry comprises a large number of original equipment manufacturers (OEMs), also known as primary contractors, system builders, equipment suppliers and a complex network of suppliers. These European OEMs produce many defence applications, which are divided into six sectors: air, naval, land, space, electronic and missile (JRC, 2016b).

New technologies will contribute to the development of even more performant defence applications. Of the emerging technologies assessed in this report, seven are considered important to Europe's defence: advanced batteries, FCs, photovoltaics, robotics, unmanned vehicles, 3DP and ICT. As these are also extensively used in the civil sectors (dual-use), the smaller defence market benefits from the larger civil mar-

ket in terms of innovation and cost. The defence sector may have different requirements for material properties and can likely invest more readily in research than industry. Its demand for raw materials, which is low in terms of volume, may also be much less elastic than the civil sector's, which means that they may acquire raw materials at a higher price than the competitive civilian market can afford.

Literature refers often to the materials used in defence applications as being 'strategic', meaning that they are not necessarily 'critical' as defined by other methodologies (Danino-Perraud, 2019). Access to raw materials, either defined as strategic or critical, is of great importance for the EU defence and aerospace industry.

Figure 56. Relevant materials and technologies to the defence and aerospace sectors

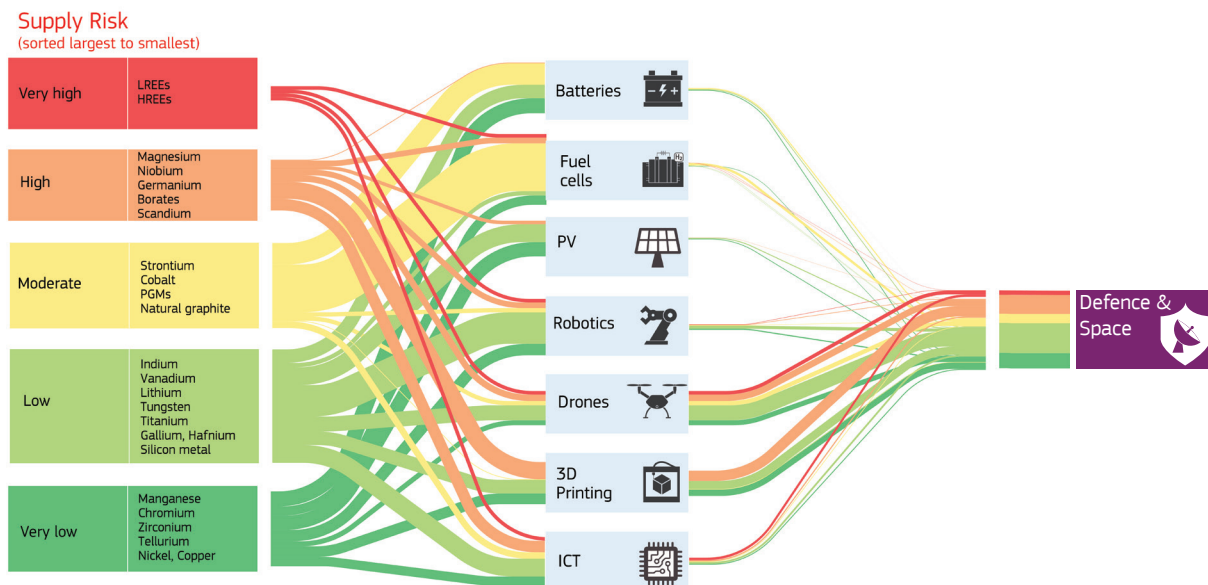

3.3.2 Raw and processed materials in the European defence and aerospace sectors

Raw materials used in the defence sector

As with many other economic sectors, the EU defence industry relies on the use of a wide range of materials with unique properties that make them essential for the manufacture of components used in military applications because the use of substitutes does not always guarantee the same performance. For example, REEs are indispensable in remotely piloted aircraft systems, precision guide munitions, targeting lasers and satellite communications. Rare earths are produced almost exclusively in China, which raises concerns not only on potential supply disruptions but also on strategic security. High-performing alloys that are used, for instance, in fuselages of combat aircraft, require specific raw materials such as niobium, vanadium or molybdenum. Other alloys are based on titanium, which provides high specific strength and corrosion

resistance, at just half the weight of steel and nickel-based super-alloys. These properties make them indispensable in aeronautic applications. Beryllium is used as a lightweight alloy in jet fighters, helicopters and satellites as it is six times lighter and stronger than steel, and thus enables reducing weight and improving speed and manoeuvrability. Beryllium finds applications also in missile gyroscopes, gimbals and for inner stage joining of elements in missile systems. Carbon fibres represent a key constituent of military aircraft, strategic missiles and satellites thanks to their superior stability, low coefficient of thermal expansions, high strength, high stiffness, low density and high abrasion resistance.

The raw materials and processed materials used in the production of relevant European defence applications are identified using a top-down approach in which in a first step the

defence applications from the land, air, naval, space, electronic and missile sectors are disaggregated into subsystems and components.

When looking at the raw materials as the constituents of the alloys and compounds, 39 raw materials are identified as mostly necessary for their production, and therefore for

the manufacture of defence-related subsystems and components. Based on their chemical structure and properties, these raw materials are grouped into four categories: metals, precious metals, REEs and non-metals (Figure 57). Of these 39 raw materials, 22 are critical for the EU economy based on the latest 2020 assessment.

Figure 57. Relevant raw materials used in defence applications.

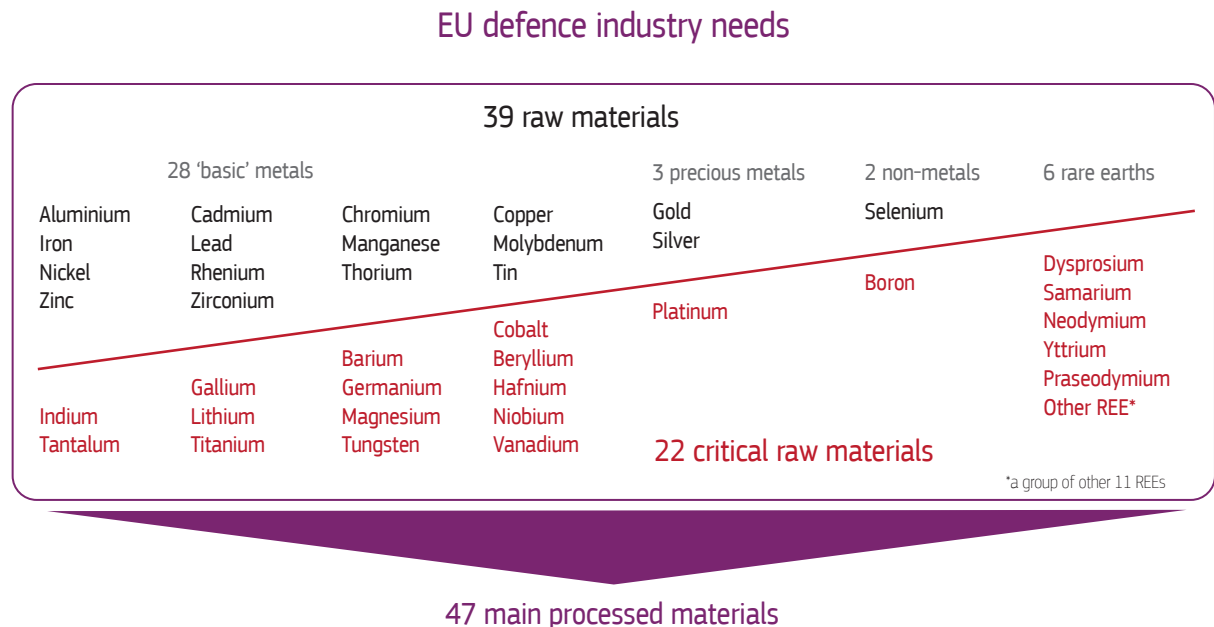

Although the demand for raw materials used in the production of defence applications is relatively low in volume, some of them are the subject of concerns over their security of supply. A particular challenge of the European defence industry is related to the downstream supply of processed materials, including materials processing know-how and transformation capabilities. The EU is a large manufacturer of alloys and special steel, but has limited production capacities for speciality composite materials and their precursors.

Many defence applications require the same materials that are also used in the civil sector. However, in some cases the defence sector needs special steels or alloys. Another difference with 'civil' materials is that the defence applications require higher purity or special composition of the alloys.

The EU is fully dependent on imports of 13 of the 39 raw materials (i.e. boron (as borates), dysprosium, gold, magnesium,

molybdenum, neodymium, niobium, praseodymium, samarium, tantalum, titanium, yttrium and other REEs). Overall, for more than two thirds of those raw materials, the share of imports exceeds 50% (Figure 58).

Based on the criticality rating assigned to these 22 CRMs and their use in the specific subsectors, aeronautics and electronics are the most vulnerable to potential materials supply constraints. In view of the strategic importance of the defence and aerospace sector for Europe's security and competitiveness, it is imperative that the related manufacturing industries operate under uninterrupted conditions. Therefore, the European defence industry needs to secure the supply of a number of raw materials from international sources, maintain its global leadership in the manufacture of high-performance alloys and special steel, and further develop capabilities for the production of speciality composite materials.



Figure 58. Use in defence applications and supply risk of raw materials used by the EU defence industry.

Supply Risk	Material	Aeronautics	Naval	Land	Space	Electronics	Missiles
6,20	● Dysprosium	●		●	●		●
6,12	● Samarium	●	●		●	●	●
6,07	● Neodymium	●		●	●	●	●
5,67	● Other REEs	●				●	
5,49	● Praseodymium						●
4,20	● Yttrium				●	●	
3,91	● Magnesium	●	●	●	●	●	●
3,90	● Niobium	●	●				●
3,89	● Germanium			●	●	●	
3,19	● Borates	●				●	●
2,54	● Cobalt	●	●	●			●
2,22	● Beryllium	●	●	●	●		
1,84	● Platinum	●		●			
1,79	● Indium	●			●	●	
1,69	● Vanadium	●	●	●			●
1,64	● Lithium	●	●	●		●	●
1,61	● Tungsten	●	●	●	●		●
1,36	● Tantalum	●				●	●
1,26	● Titanium	●	●	●	●		●
1,26	● Baryte	●		●		●	
1,26	● Gallium	●			●	●	
1,12	● Hafnium	●			●	●	
0,94	● Molybdenum	●	●	●			●
0,93	● Manganese	●	●	●	●		
0,90	● Tin	●					
0,86	● Chromium	●	●	●	●		●
0,83	● Zirconium	●	●		●		●
0,68	● Silver	●				●	
0,59	● Aluminium	●	●	●	●		●
0,49	● Nickel	●	●	●	●		●
0,46	● Iron ore	●	●	●	●		●
0,45	● Rhenium	●			●		
0,41	● Selenium	●				●	
0,34	● Cadmium	●					
0,34	● Zinc	●	●		●	●	●
0,32	● Copper	●	●		●	●	
0,19	● Gold	●			●	●	
0,09	● Lead	●	●			●	●

Materials used in aeronautic defence applications

The defence industry's aeronautics sub-sector is facing the biggest challenges, as it requires a large number of very specialised, innovative and complex materials, such as composites and alloys, along with titanium, graphite or fibreglass. The materials used in aeronautic applications are also denoted as 'aerospace materials' and the most relevant are the following: aluminium alloys, steel alloys, titanium alloys, super-alloys, composite materials and other materials such as ceramics, GLARE – glass laminate aluminium reinforced epoxy, magnesium and special alloys.

With the evolution of the aeronautics industry, traditionally used materials such as metals and metal-based alloys are constantly being replaced by new lightweight materials such as titanium alloys, composite materials, especially those made from glass and carbon fibres, and high-temperature-resistant plastics. For example, new generations of aircrafts use up to 50% composites (Figure 59). These materials offer greater strength characteristics compared with traditional

materials, providing greater resistance and less weight. In the defence industry, this translates into higher manoeuvrability and long-distance independency (low fuel consumption) of jet fighters. As an example, the distribution of materials in the various parts of the Rafale fighter aircraft is presented in Figure 60.

Europe's alloy industry is represented by companies along the entire value chain of materials. These companies are engaged in the production, processing and supply of specialised high-performance alloys covering a wide area of end-users, including the defence industry sector. However, the EU lacks major manufacturers of aerospace-grade carbon fibres and their precursors, e.g. polyacrylonitrile (PAN), which are needed for composite materials and are currently mainly produced in Japan and the USA. In spite of the limited production within the EU of all materials used in defence applications, at the present time there is a potential low-to-moderate supply chain bottleneck for aerospace materials and other semi-finished materials used by EU defence industries.

Figure 59. Estimated composites loading in various defence aeronautic applications

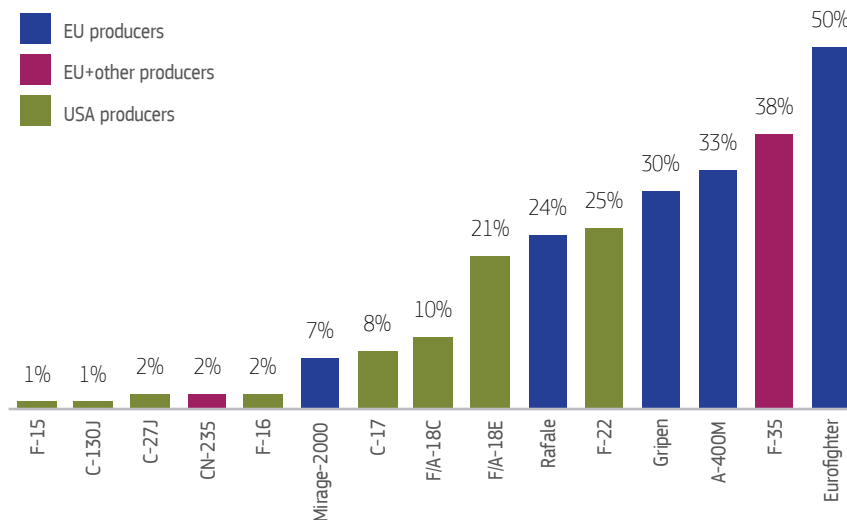

Materials used in space applications

Although the space sector is a high-end niche that represents few revenues compared to its associated services market such as the global telecommunications sector, its growth has constantly outperformed worldwide economic growth over the last decade (Oleson, 2016). The space industry today is experiencing an innovation-driven paradigm shift, leading to the 'democratisation' and 'industrialisation' of space (OECD, 2016). The deployment of mega-constellation systems today is a reality while more and more private actors are involved in space activities. An important growth of the launch rates and thus satellites population is expected in the next decades (Muelhaupt et al., 2019). This new international trend could

have an impact on the availability of certain advanced materials like carbon fibres, precursors, resins and special alloys for European space projects in the next decades.

Materials are the elementary blocks for building spacecrafts, satellites or launch systems. Sometimes, the limitations in materials properties and availability shape the design of the space product. For example, the design of the Space Shuttle systems encountered many material challenges, such as weight savings, reusability, and operating in the space environment. Materials are also critical for space flight safety, with two Space Shuttle accidents caused by materials failures (Challenger and Columbia).



Figure 60. Materials used in different parts of the combat aircraft Rafale

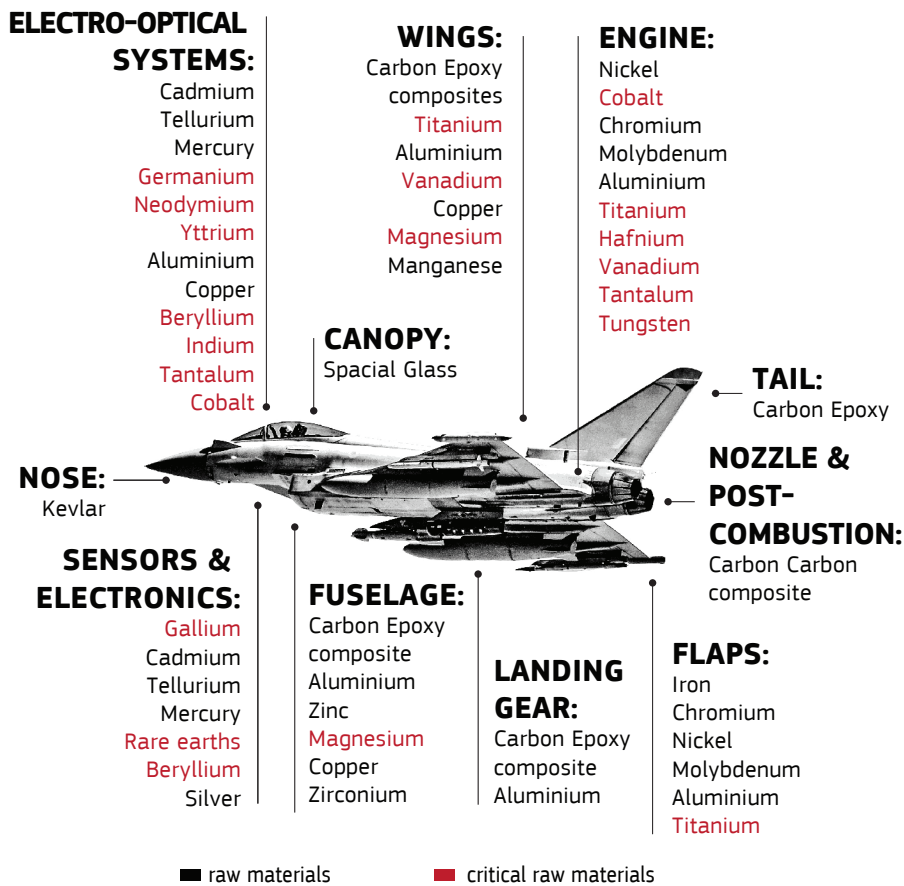

The literature lacks of comprehensive overviews of raw and advanced materials needed in the space sector. The European Space Agency (ESA) released some information during a past workshop, including:

- ▶ Typically, the quantity of materials for satellites is small depending on the type of satellite. Launchers however use larger volumes (the Vega launcher weighs 137 t); and material types are well defined for long periods of time (the lifetime of a launcher is about 20 years);
- ▶ Supply concerns regard the availability of carbon fibre composites of high modulus of elasticity for space applications. There is only one Japanese manufacturer and the European industry has potential access only to a fraction of their production with the majority reserved for the American market;
- ▶ There is limited European production capability for resins (1-2 companies). The performance of 'no-name' resins from Asia is untested;
- ▶ There are some concerns regarding the availability of high strength aluminium alloys (7075 series) because of the small quantities needed by the market;

- ▶ Titanium is readily available, however the origin is not possible to trace in the global market.

Materials for space applications differ from standard applications. They need to operate in extreme conditions and environments and thus require particular properties control during long R & D phase, testing and qualification procedures to comply with the space industry standards (ESA, 2020). Consequently, the substitution of materials and processes aiming to decrease the supply risk in the space sector is not straightforward.

In parallel, the end-of-life recycling appears challenging. The use of recycled germanium has been considered for solar arrays by the ESA (Kurstjens et al., 2018). However, the use of recycled material is currently disregarded for the majority of space applications (that use pristine materials exclusively). Apart from the reuse of the launcher lower stages, the recovery of materials at the end of the mission is not realistic. It comes from the current design of space missions: a systematic dissipation of the materials occurs in the outer space environment or during the atmospheric re-entry.

Supply chain bottlenecks for emerging technologies relevant to the defence sector

Like for the two other sectors, the weakest steps in the supply chain of the seven selected technologies are the supply of raw materials and final assemblies. This counts in particular for Li-ion batteries and FCs, but also to a lesser extent to drones. The dependence of the EU on the supply of raw materials for these emerging technologies is extremely high (Figure 61). The EU produces on average around 3% of the overall raw materials required in these technologies (without considering digital technologies). China dominates global pro-

duction, supplying around more than half of the raw materials. The other half of the raw materials is produced by numerous small suppliers with minor shares of global production. At the components level, though some supply risks are detected for Li-ion batteries and drones, solar PV and robotics seems to be the most vulnerable of the technologies. The supply of processed materials is shown to be particularly critical for Li-ion batteries.

Figure 61. Potential supply risks in the value chains and key suppliers of emerging technologies relevant to the European defence sector

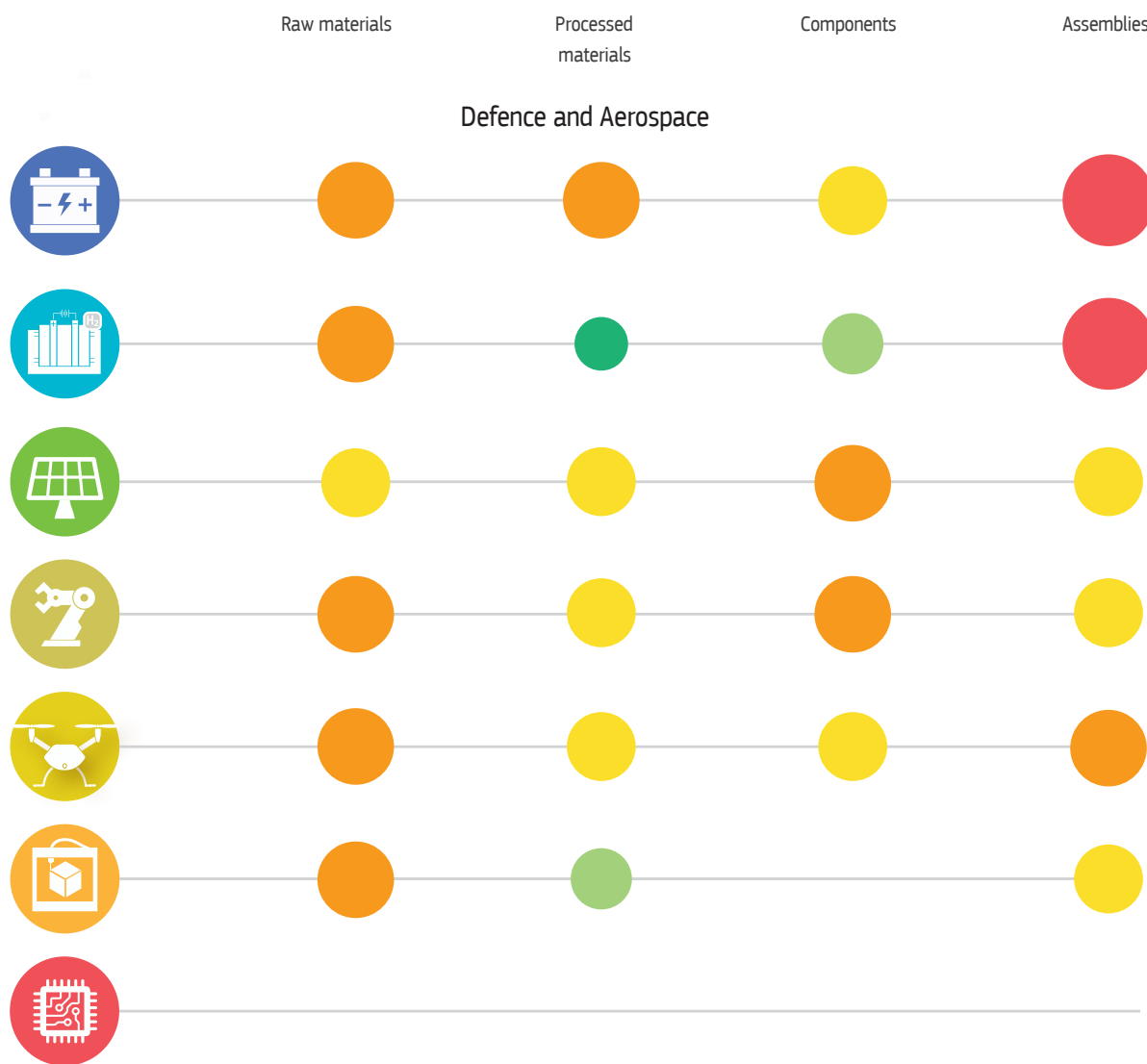



3.3.3 Key observations and recommendations

The defence and aerospace sector's materials supply chain is a complex multi-level network of material suppliers, manufacturers, distributors and retailers/wholesalers. An efficient supply chain should ensure a timely delivery at competitive prices of all intermediate and final products to the original equipment manufacturers (OEMs). The supply chain involves various stages, such as the supply of raw materials, metal refining and processing (e.g. alloying or composite production) and conversion into semi-finished and finished products. A strong and sustainable materials supply chain is essential for the overall growth and competitiveness of the European defence and aerospace industry. In the case of European sector, the ESA promotes the geographic return rules, which increases the number of suppliers throughout Europe (OECD, 2014) and involves a complex logistic until the final assembly. Therefore, the monitoring of the supply chain from raw material extraction until the end-product is often more demanding than other sectors.

The space sector is a technological enabling sector. Its most important role is not transmitting data or imagery through spacecraft, but rather enabling industries and markets with the produced data (PwC, 2017b). The development of hybrid systems merging terrestrial and space system activities could de-compartmentalise the sector during the next decade. For instance, drone or airborne imagery integrated into high-resolution satellite remote sensing, or hybrid-telecommunication/internet system (e.g. for 5G application) could be envisaged (Marchese et al., 2019).

China is the major global producer of 58% of raw materials identified as important for defence applications (Figure 62). The supply risk of raw materials produced in this country is considered high and it may be interrupted (e.g. by imposing export restriction and taxes). Among these 39 raw materials, the EU is the largest global supplier for hafnium only.

Figure 62. Key players in the supply of raw materials used in defence sector

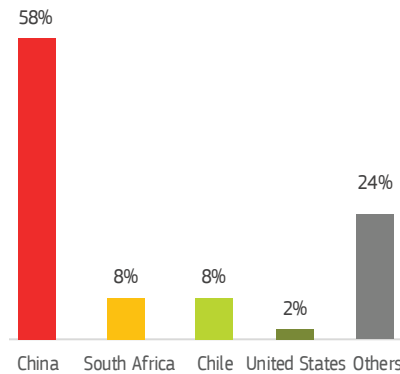

A number of actions need to be taken for better understanding of and improving the security of supply of raw and processed/semi-finished materials used in the European defence and aerospace industry, including:

- ▶ Promoting R&D programmes for the development of high-tech and advanced materials;
- ▶ Strengthening the downstream segment of its materials supply chain and, in particular, materials processing know-how and materials transformation capabilities;
- ▶ Improving the knowledge base for the materials used, for example by promoting information sharing between all relevant stakeholders.

Regarding the materials supply risk for emerging technologies relevant to the defence and aerospace sector, it is important that the EU reduces its dependency and increases security of via diversification of supply of raw materials and components. Besides increasing domestic production, other strategies include the substitution of critical materials, recycling and finding alternative suppliers. Stockpiling could be one of the options to mitigate short- to medium-term supply disruptions in the event of a crisis.

3.4 Sectorial competition and securing future raw materials supply

Sectorial competition for raw materials

Many critical materials have a range of applications in various industrial sectors, including renewable energy, e-mobility, defence and aerospace and digital sectors, as well as medical, chemical and petrochemical sectors. There will be an increasing competition between all sectors for the same raw materials, processed materials as well as components. This applies for example to critical raw materials such as borates, gallium, indium, rare earths, cobalt, niobium and silicon metal. As the mineral commodities are traded on international markets, and as other key countries such as the USA and China are

reliant on imports for some of them (e.g. for niobium, chromium, tantalum), their availability to the EU might become even more demanding. Competition between world regions for the access to raw materials will become more acute as a result of the transition towards a low-carbon economy and based on new industrial strategies.

Figure 63 shows the future cumulative EU annual material demand for the e-mobility plus renewables sector (no quantitative data is available for defence and aerospace sectors). (See Annex 1 – Methodological notes and Annex 2 – Data tables for more information)

Figure 63. EU annual material demand for e-mobility and renewables combined in 2030 and 2050





The security of supply with regard to material dependence should therefore be regarded through a supply chain approach, taking into account the linkages between various supply chain steps, and even various regions of the world. A permanent monitoring of raw materials markets and (strategic) supply chains is necessary and industry and policymakers

need to work together to ensure access to up-to-date reliable information for the Member States and stakeholders (e.g. as done in the Raw Materials Information System) in relation to the most critical CRMs. The exchange of data and information and international cooperation, should be supported in an integrated manner at EU, Member State and corporate levels.

Future supply–demand balances on raw materials

Many factors come into play when the supply–demand balance would become tight in the future: the defence sector for example will not accept production stops and will most probably have precedence in acquiring the necessary raw materials for its comparatively small demand.

A high growth rate as displayed in Figure 63 does not directly convert to a raw material supply bottleneck in the future. This depends on the overall supply–demand balance. For the raw material supply part of this balance, the combination of raw material prices linked to mining investments and technical possibilities for upscaling extraction and refining capacities combined determine supply ‘flexibility’ for the future.

The main concerns about the ultimate future supply capacities for selected material are the following. For REEs (dysprosium, neodymium and praseodymium), end-users outside of China will remain vulnerable on China’s dominance of the global rare earth value chain (mining, oxides, metals, alloys and magnets) in the foreseeable future. The rising annual demand for neodymium and dysprosium globally will significantly exceed global annual production by 2030. After the depletion of historically accumulated reserves, shortages are foreseen in case additional sources of supply are not developed (Adamas Intelligence, 2019). Dysprosium is more vulnerable to supply deficit due to its low natural relative proportion in most REE ores.

A structural change in supply is expected for the already constrained nickel market driven by the shift of the demand towards nickel class-1. High-purity class-1 nickel (cathodes, carbonyl nickel, briquettes, powders, etc.) is used in a wide range of applications, including special steel and batteries, and accounted for 43 % of global nickel output in 2018 (Nickel Institute, 2018). Class-2 nickel is used for stainless steel production and accounted for 57% of world nickel production in 2018. Ramping up supply to avoid a shortfall in the increasing demand for class-1 nickel requires sufficient and timely investments in mining and especially in refining capacity. Technological challenges, lack of investments in nickel

projects worldwide due to recent low price levels, long lead times to bring new capacity online, as well as resource nationalism (e.g. export ban imposed by top-producer Indonesia) pose significant risks for the class-1 nickel market balance.

For lithium, the market is currently in surplus due to recent additions in mining and refining capacity. In the short term, projects in the pipeline can keep the market balanced. However, further and large investments are needed at the global level to meet the fast-growing demand in the medium term, and from 2024-2025 the market is expected to start moving towards a severe volume deficit. Despite the remarkable growth in demand, physical lithium shortages are not expected in the long term given the high amount of global resources (Infinity Lithium, 2019).

For cobalt, the primary concern identified for the future security of supply is the high supply concentration. Democratic Republic of the Congo currently holds about 60% of the global mine output of cobalt, and China over 60% of the refined output. With substantial reserves, Democratic Republic of the Congo will also drive the required additional mine supply to the market in the future. However, low governance and high instability, in combination with the high proportion (10-20%) of artisanal and small-scale mining in the country’s output pose significant concerns to meet demand in the future. Depending on the prevailing battery chemistries and despite ongoing substitution efforts, additional mining projects may need to be developed to avoid a market deficit from 2025 onwards.

For graphite, the outlook for natural graphite mine supply is positive as several companies continue to develop new mining projects, e.g. in Africa. Overconcentration of supply in China for spherical graphite used in battery anodes might pose a challenge for the future. Since synthetic graphite is a potential substitute for natural graphite, growing demand for battery-grade spherical graphite can be met by increasing the production of synthetic graphite.



4 Conclusions and Recommendations



The novelty of this foresight study lies in the systematic and homogeneous description of supply chain dependencies ranging from raw materials, processed materials, components to final assemblies across multiple technologies and sectors. Individual technologies and sectors compete for the same raw materials and processed materials. These materi-

als are the basis for all industrial value chains and ultimately contribute to societal well-being. This study contributes to various actions listed in the Communication “Critical Raw Materials Resilience: Charting a Path towards greater Security and Sustainability” (European Commission, 2020) to secure current and future supply of materials:

Build and use knowledge and intelligence

The information provided in this study offers a first overview of current situation and foresights for a selection of key technologies and sectors. The analysis conducted can act as a template for follow-up research and deepened analyses for individual materials, technologies and sectors towards a more complete foresight of raw materials needs for the future as well as to a more permanent and structural monitoring of raw material markets.

It is recommended to:

- ▶ Improve and harmonise data for the technologies evaluated in this study. Supplement the analysis of technologies analysed only qualitatively so far: This counts for robotics, drones and 3DP technologies and digital technologies and the defence sector. Further assessment of additional relevant technologies and sectors is advised.
- ▶ Improve the foresight methodology applied, originally developed for the Materials for Dual Use report (JRC, 2019a). Consistency can be improved by removing overlaps in current indicators and by including more recent information and data.
- ▶ For certain materials, the actual EU consumption numbers are rather incomplete or highly uncertain due to their presence in imports of many different products which is difficult to extract from trade data. It is advised to further the Material System Analyses. Additionally, the current focus in demand and supply is on the EU. Obviously, trends in the rest of the world need to be considered.
- ▶ Further analysis of the supply side flexibility and foresight for minerals production are needed in order to construct more insight in the overall supply–demand balances for the most relevant raw materials.

Strengthen resilience of industrial ecosystems

This foresight study provides a starting point for industry and governments in decision-making, for example for formulating resource specific security strategies in management planning of both the EU, member states and companies. The outcomes point to directly to the most relevant materials and/or supply chain stages with the highest supply risk for each sector.

It is recommended to:

- ▶ Regularly update and deepen this analysis to more value chains like digital technologies, artificial intelligence, more defence and space applications and other new manufacturing technologies.

Economic diplomacy

The identification of the relation between countries associated to supply of different raw materials, processed materials, components and assemblies for each industrial supply chain is a crucial starting point. Figure 65 reports the main countries holding significant shares of the supply chain stages per technology evaluated.

To define targets and objectives related to economic diplomacy, sustainable sourcing and use of EU domestic potential, more precise and comprehensive information is needed on the current state of play.

It is recommended to:

- ▶ Investigate new (material) innovation partnerships with material suppliers in the EU as well as in third countries to enhance cooperation; improve raw material and processed materials quality as well as availability for high-tech applications to secure future supply of raw materials for strategic value chains;
- ▶ Besides attention to the physical origins of materials, components and assembly, protection of valuable intellectual property should also get attention. Although not explicitly mentioned so far, in many cases in this analysis, concerns are raised by experts regarding IPR protection of innovations originating from the EU (JRC, 2019a).
- ▶ The Screening of Foreign Direct Investments regulation specifically mentions dual-use components and critical supply and raw materials in Article 4 to detect whether such investments affect security or public order. In addition, the regulation also mentions access to sensitive information as a factor to be taken into consideration (e.g. Horizon 2020 is mentioned in this context). As such, we recommend that the risk created by inward FDIs in the selected value chains should be assessed on all relevant EU assets, whether fixed or intangible. This could be supplemented by an analysis of European outward Direct Investments in the respective global supply and value chains to assess EU leadership and whether there are restrictions – a non-level playing field for our industries.

Better use of domestic potential, circular economy and sustainable sourcing

Potential cross-sectoral cooperation and alliances to secure access to raw materials requires cross-sectoral understanding of competition for the same materials supply. It is important to identify overlaps in new material demands to explore synergies in creating stable markets for the respective materials. The same counts for identification of competition for the same materials expected to see a high demand increase in the future as illustrated in this study. Synergies can be explored for materials present in one sector that could become available via reuse, refurbishing and recycling for other sectors at a later stage.

It is recommended to:

- ▶ Analyse the impact of low-carbon technologies on the environmental footprint related to related greenhouse gas emissions embedded in raw material imports and the social footprint and acceptance of new mining projects inside the EU and the social effects of growing material consumption outside the EU to realise sustainable sourcing;
- ▶ Extend the current analysis per technology to quantify the potential role of recycling, reuse and remanufacturing to reduce dependencies, which was not included in the scope of this study.

Develop innovation and skills for the digital age

Skills, educational capacities for a range of relevant disciplines are required for the envisaged transition to a low-carbon economy. Due to mobilisation of research and international research projects, substantial progress is made already to realise dematerialisation by means of substitution.

It is recommended to:





- ▶ Give further attention to research and innovation in material sciences, geosciences and metallurgy to remain internationally competitive. When developing resource diversification strategies, skills and innovation are a core ingredient to realise environmentally, economically and socially efficient processes, material efficiency and successful substitution strategies.
- ▶ Develop technical capabilities related to processing of a range of metals like niobium, hafnium, zirconium and scandium: Their availability enables innovations in advanced materials properties like weight reduction, high strength and corrosion resistance for a wide range of technologies and value chains;

A comprehensive list of 42 materials evaluated in this study on their use in strategic technologies is provided in Figure 64. It can be used when further evaluating and quantifying the amounts of the most relevant materials in individual technologies.

Figure 65 shows the main locations of raw materials production, processed materials, components and assembly manufacturing, respectively, aggregated for all assessed technologies. It shows that the main concerns relate to the raw materials stage, with roughly 3 % of the origin related to EU countries and a large share of mining and refining production from China.

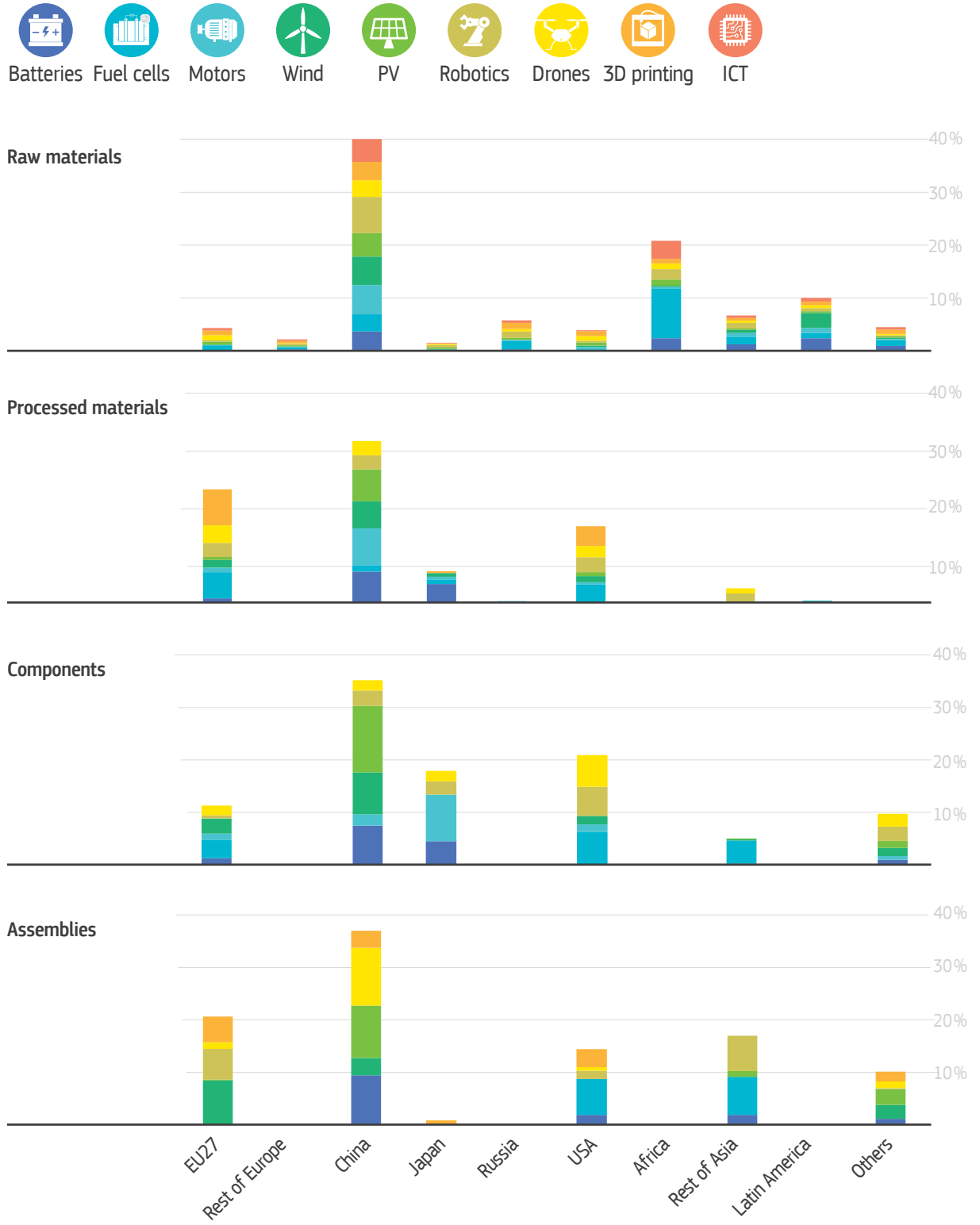

Figure 64. List of critical and non-critical raw materials use in different technologies with their supply risk

Supply Risk	Material								
5,98	● LREEs		●	●	●		●	●	●
5,63	● HREEs		●	●	●		●	●	
3,91	● Magnesium		●				●	●	●
3,90	● Niobium	●		●				●	●
3,89	● Germanium				●			●	●
3,55	● Phosphorus	●					●	●	●
3,19	● Borates		●	●	●		●	●	●
3,09	● Scandium							●	●
2,57	● Strontium		●				●	●	
2,54	● Cobalt	●	●	●			●	●	●
2,38	● PGMs		●				●	●	●
2,29	● Beryllium							●	
2,27	● Natural graphite	●	●				●	●	●
2,22	● Bismuth						●	●	●
2,01	● Antimony						●	●	
1,79	● Indium				●		●	●	
1,69	● Vanadium		●				●	●	●
1,64	● Lithium	●	●				●	●	
1,61	● Tungsten						●	●	●
1,36	● Tantalum						●	●	
1,15	● Fluorspar	●					●	●	
1,26	● Titanium	●	●				●	●	●
1,26	● Gallium				●		●	●	●
1,19	● Arsenic		●				●	●	●
1,18	● Silicon metal	●	●		●		●	●	●
1,12	● Hafnium							●	●
0,94	● Molybdenum		●	●	●		●	●	●
0,93	● Manganese	●	●	●			●	●	●
0,90	● Tin	●			●		●	●	●
0,86	● Chromium		●	●			●	●	●
0,83	● Zirconium		●				●	●	●
0,68	● Silver		●		●		●	●	●
0,59	● Aluminium	●	●	●	●		●	●	●
0,51	● Tellurium				●		●	●	●
0,49	● Nickel	●	●		●		●	●	●
0,46	● Iron Ore	●	●	●	●		●	●	●
0,41	● Selenium	●	●				●	●	●
0,34	● Zinc				●		●	●	
0,34	● Cadmium				●		●	●	●
0,32	● Copper	●	●	●	●		●	●	●
0,19	● Gold		●				●	●	●
0,09	● Lead	●		●	●		●	●	●

Materials in red are critical raw materials. LREEs, HREEs and PGMs are groups of multiple raw materials.

Figure 65. Key suppliers of raw materials, processed materials, components and assemblies for eight technologies in total represented as country shares



Bibliography

- Adamas Intelligence**, Rare Earth Elements: Market Issues and Outlook, Available at: <https://www.adamasintel.com/rare-earth-market-issues-and-outlook/>, 2019.
- BCG**, 'Additive Manufacturing', 2018 .
- BloombergNEF**, 'Equipment Manufacturers', 2020.
- Bonilla**, S.H., H.R.O. Silva, M.T. da Silva, R.F. Gonçalves, and J.B. Sacomano, 'Industry 4.0 and Sustainability Implications: A Scenario-Based Analysis of the Impacts and Challenges', *Sustainability*, Vol. 10, No. 10, 2018.
- CBMM**, Sustainability report 2018
- Ciacci**, L., T.T. Werner, I. Vassura, and F. Passarini, 'Backlighting the European Indium Recycling Potentials', *Journal of Industrial Ecology*, Vol. 23, No. 2, 2019, pp. 426–437.
- Coughlin**, T., '175 Zettabytes By 2025', *Forbes*, 2018.
- Danino-Perraud**, R., 'The Consequences of Military Technology Evolution Regarding the Needs of Rare Metals : The Question of the Security of Supplies', Université d'Orléans, 2019.
- Deloitte Sustainability**, British Geological Survey, Bureau de Recherches Géologiques et Minières, and Netherlands Organisation for Applied Scientific Research, Study on the Review of the List of Critical Raw Materials - Criticality Assessment, Report prepared for the European Commission. Available at <https://publications.europa.eu/en/publication-detail/-/publication/08fdab5f-9766-11e7-b92d-01aa75ed71a1/language-en>, 2017.
- EC**, Digitisation Research and Innovation. Transforming European Industry and Services, 2017.
- EPRS | European Parliamentary Research Service**, Civil and Military Drones Navigating a Disruptive and Dynamic Technological Ecosystem, 2019.
- European Commission**, The European Green Deal, COM(2019) 640 final, 2019.
- European Commission**, Communication 'Critical Raw Materials Resilience: Charting a Path towards greater Security and Sustainability', COM(2020) 474 final, 2020.
- European Political Strategy Centre**, Rethinking Strategic Autonomy in the Digital Age, 2019.
- ESA 2020**, https://www.esa.int/Science_Exploration/Space_Science/Building_and_testing_spacecraft
- Fraunhofer ISI**, Photovoltaics Report, 2019.
- Garrett**, P., and K. Rønne, Life Cycle Assessment of Electricity Production from an Onshore V112-3.45MW Wind Plant, Vestas Wind Systems, 2017.
- Ginley**, D.S., and D. Cahen, *Fundamentals of Materials for Energy and Environmental Sustainability*, Cambridge University Press, 2012.
- Hao**, H., Y. Geng, J.E. Tate, F. Liu, X. Sun, Z. Mu, D. Xun, Z. Liu, and F. Zhao, 'Securing Platinum-Group Metals for Transport Low-Carbon Transition', *One Earth*, Vol. 1, No. 1, 2019, pp. 117–125.
- Harrison**, G., and C. Thiel, 'An Exploratory Policy Analysis of Electric Vehicle Sales Competition and Sensitivity to Infrastructure in Europe', *Technological Forecasting and Social Change*, Vol. 114, 2017, pp. 165–178.
- Hernandez**, M., M. Messagie, O. Hegazy, L. Marengo, O. Winter, and J. Van Mierlo, 'Environmental Impact of Traction Electric Motors for Electric Vehicles Applications', *International Journal of Life Cycle Assessment*, Vol. 22, No. 1, 2017, pp. 54–65.
- Hill**, N., D. Clarke, L. Blair, and H. Menadue, *Circular Economy Perspectives for the Management of Batteries Used in Electric Vehicles*, 2019.
- Infinity Lithium**, Pre-feasibility study San Jose Valdeflorez Lithium Hydroxide Project, 2019
- IRENA**, *Electricity Storage and Renewables : Costs and Markets To 2030*, 2017.
- Jean**, J., P.R. Brown, R.L. Jaffe, T. Buonassisi, and V. Bulović, 'Pathways for Solar Photovoltaics', *Energy and Environmental Science*, Vol. 8, No. 4, 2015, pp. 1200–1219.
- JRC**, Assessment of Potential Bottlenecks along the Materials Supply Chain for the Future Deployment of Low-Carbon Energy and Transport Technologies in the EU. Wind Power, Photovoltaic and Electric Vehicles Technologies, Time Frame: 2015-2030, Joint Research Centre (JRC). Authors: Blagoeva, D.T., P. Aves Dias, A. Marmier, and C.C. Pavel. JRC103778, 2016a.
- JRC**, Raw Materials in the European Defence Industry, Joint Research Centre (JRC), Authors: Pavel, C.C., and E. Tzimas. Pavel, C.C., and E. Tzimas, 2016b.
- JRC**, Materials Impact on the EU's Competitiveness of the Renewable Energy, Storage and e-Mobility Sectors - Wind Power, Solar Photovoltaic and Battery Technologies, Joint Research Centre (JRC), Authors: Claudiu Pavel, Darina Blagoeva. EUR 28774 EN, Publications Office of the European Union, Luxembourg, 2017, ISBN 978-92-79-73491, 2017a.
- JRC**, Critical Raw Materials and the Circular Economy - Background Report, Authors: Mathieux, F., F. Ardente, S. Bobba, P. Nuss, G.A. Blengini, P. Alves Dias, D. Blagoeva, et al., JRC-EC (Joint Research Centre - European Commission) Science-for-policy report, EUR 28832 EN, Publications Office of the European Union, Luxembourg, 2017b.

- JRC**, Cost Development of Low Carbon Energy Technologies - Scenario-Based Cost Trajectories to 2050, authors: Tsiropoulos, I., D. Tarvydas, and A. Zucker, , 2017 Edition, EUR 29034 EN, JRC109894, Luxembourg, 2018a.
- JRC**, IN-DEPTH ANALYSIS IN SUPPORT OF THE COMMISSION COMMUNICATION COM(2018) 773 A Clean Planet for All A European Long-Term Strategic Vision for a Prosperous, Modern, Competitive and Climate Neutral Economy, 2018b.
- JRC**, Cobalt: Demand-Supply Balances in the Transition to Electric Mobility, Joint Research Centre (JRC). Authors: Alves Dias, P., D. Blagoeva, C.C. Pavel, and N. Arvanitidis. JRC112285, 2018c
- JRC**, 'Raw Materials Information System (RMIS)', 2019a.
- JRC**, Materials Dependencies for Dual-Use Technologies Relevant to Europe's Defence Sector, Joint Research Centre (JRC), Authors: Blagoeva, D., C. Pavel, D. Wittmer, J. Huisman, and F. Pasimeni. JRC118394, 2019b.
- JRC**, The Future of Road Transport - Implications of Automated, Connected, Low-Carbon and Shared Mobility, Joint Research Centre (JRC), Authors: Alonso Raposo, M., B. Ciuffo, F. Ardente, J.P. Aurambout, G. Baldini, R. Braun, P. Christidis, et al.. JRC116644, 2019c.
- JRC**, Wind Energy Technology Market Report, Joint Research Center (JRC), Authors: Thomas Telsnig, Cristina Vazquez Hernandez. EUR 29922 EN, JRC118314, 2019d.
- JRC**, Raw materials demand for wind and solar PV technologies in the transition towards a decarbonised energy system, Authors: Carrara S., Alves Dias P., Plazzotta B. and Pavel C.; EUR 30095 EN, Publication Office of the European Union, Luxembourg, 2020, ISBN 978-92-76-16225-4, doi:10.2760/160859, JRC119941, 2020a.
- JRC**, RMIS – Raw materials in the battery value chain, authors: Huisman, J., Ciuta, T., Mathieux, F., Bobba, S., Georgitzikis, K. and Pennington, D., Publications Office of the European Union, Luxembourg, 2020, ISBN 978-92-76-13854-9 (online), doi:10.2760/239710 (online), JRC118410, 2020b.
- Ku**, A.Y., 'Anticipating Critical Materials Implications from the Internet of Things (IOT): Potential Stress on Future Supply Chains from Emerging Data Storage Technologies', Sustainable Materials and Technologies, Vol. 15, No. October 2017, 2018, pp. 27–32.
- R. Kurstjens**, M. Schurmans, K. Dessen. Increasing Ge resource efficiency for future low-CO2 multijunction solar cells. Clean Sp. Ind. Days, ESA - Clean Space, ESTEC, Noordwijk. 2018. https://indico.esa.int/event/234/contributions/4026/attachments/3055/3782/2018CSID_RKurstjens_UmicoresStrategyToIncreaseGermaniumResourceEfficiency.pdf
- Leader**, A., and G. Gaustad, 'Critical Material Applications and Intensities in Clean Energy Technologies', Clean Technologies, Vol. 2, No. 1, 2019, pp. 11–31.
- Leader**, A., G. Gaustad, and C. Babbitt, 'The Effect of Critical Material Prices on the Competitiveness of Clean Energy Technologies', Materials for Renewable and Sustainable Energy, Vol. 8, No. 2, 2019, pp. 1–17.
- Månberger**, A., and B. Stenqvist, 'Global Metal Flows in the Renewable Energy Transition: Exploring the Effects of Substitutes, Technological Mix and Development', Energy Policy, Vol. 119, No. April, 2018, pp. 226–241.
- Marchese**, M., Moheddine, A., & Patrone, F., IoT and UAV Integration in 5G Hybrid Terrestrial-Satellite Networks, 2019. <https://doi.org/10.3390/s19173704>
- Marscheider-Weidemann**, F., S. Langkau, T. Hummen, L. Erdmann, and L. Tercero Espinoza, Raw Materials for Emerging Technologies 2016, Fraunhofer-Institut für System- und Innovationsforschung ISI, 2016.
- Monnet**, A., and A. Ait Abderrahim, Report on Major Trends Affecting Future Demand for Critical Raw Materials. SCREEN Project D.2.2, 2018.
- Muelhaupt**, T. J., Sorge, M. E., Morin, J., & Wilson, R. S., The Journal of Space Safety Engineering 'Space traffic management in the new space era'. 6(May), 2019, pp. 80–87. <https://doi.org/10.1016/j.jsse.2019.05.007>
- Nassar**, N.T., D.R. Wilburn, and T.G. Goonan, 'Byproduct Metal Requirements for U.S. Wind and Solar Photovoltaic Electricity Generation up to the Year 2040 under Various Clean Power Plan Scenarios', Applied Energy, Vol. 183, 2016, pp. 1209–1226.
- Nickel Institute 2018**, Nickel: Fact and figures; CRM4EV Workshop, Brussels, 15th -16th November 2018
- OECD**, The Space Economy at a Glance 2014. <https://doi.org/10.1787/9789264217294-en>
- OECD**, New trends in space innovation. In Space and Innovation, 2016. <https://doi.org/10.1787/9789264264014-2-en>
- Oleson**, G., Effects of changing economics on space architecture and engineering. 32st Space Symposium, 2016, pp. 1–12. Retrieved from <http://2016.spacesymposium.org/sites/default/files/downloads/Oleson,%20Gary%20-%20Effects%20of%20Changing%20Economics%20on%20Space%20Architecture%20and%20Engineering%20.pdf>
- Pavel**, C.C., C. Thiel, S. Degreif, D. Blagoeva, M. Buchert, D. Schüler, and E. Tzimas, 'Role of Substitution in Mitigating the Supply Pressure of Rare Earths in Electric Road Transport Applications', Sustainable Materials and Technologies, Vol. 12, 2017, pp. 62–72.
- Polman**, A., M. Knight, E.C. Garnett, B. Ehrler, and W.C. Sinke, 'Photovoltaic Materials: Present Efficiencies and Future Challenges', Science, Vol. 352, No. 6283, 2016.
- Polverini**, D., F. Ardente, I. Sanchez, F. Mathieux, P. Tecchio, and L. Beslay, 'Resource Efficiency, Privacy and Security by Design: A First Experience on Enterprise Servers and Data Storage Products Triggered by a Policy Process', Computers and Security, Vol. 76, 2018, pp. 295–310.

PwC, Innovation for the Earth Harnessing Technological Breakthroughs for People and the Planet, 2017a.

PwC, Copernicus ex-ante benefits assessment, Executive Summary. 2017b. Retrieved from: <https://www.copernicus.eu/sites/default/files/documents/Copernicus-Ex-Ante-Executive-Summary.pdf>

Reinsel, D., J. Gantz, and J. Rydning, 'Data Age 2025: The Digitization of the World From Edge to Core', International Data Corporation, No. November, 2018, p. 28.

Research and Markets, 'Global and China Polysilicon Industry Report 2019-2023', 2019.

Reuters Business News, 'Platinum's Days as Fuel Cell Car Component May Be Numbered', 2018.

Roskill, Lithium-Ion Batteries Market Development & Raw Materials, Second Edition, 2018.

Ryan, J., and C. Martin, 'Solar Companies Are Scrambling to Find a Critical Raw Material', Bloomberg, 2017.

SESAR Joint Undertaking, European Drones Outlook Study, 2016.

Statista, '3D Printing Market Distribution Worldwide in 2016, by Use Case', 2018.

Statista, Statista Dossier Commercial UAVs, 2019.

Statista, Projected Compound Annual Growth Rate of the Global Robotics Market between 2000 and 2025, by Segment, 2016.

Sun, Y., M. Delucchi, and J. Ogden, 'The Impact of Widespread Deployment of Fuel Cell Vehicles on Platinum Demand and Price', International Journal of Hydrogen Energy, Vol. 36, No. 17, August 1, 2011, pp. 11116–11127.

Tercero, L., Report on the Future Use of Critical Raw Materials. SCRREEN Project D.2.3, 2019.

The Business Research Company, Robotics Market and Supply Chain Long Term Assessment for the EU Market, 2018.

Trinomics, 'Study on Energy Technology Dependence', 2019.

Widmer, R., and P. Wäger, 'ICT Hardware - Materials: Scarce Metals as Raw Materials for ICTs: Do We Care Enough?', 2013.

Glossary

3C	computer, communication, and consumer electronics
3DP	3D Printing
CAGR	Compound Annual Growth Rate
CIGS	Copper Indium Gallium Selenide thin film in PV
CRM	Critical Raw Material
DMD	Direct Metal Deposition
DMLS	Direct Metal Laser Sintering
EBM	Electron Beam Manufacturing
ESS	Energy Storage System
EC	European Commission
EU	European Union
EV	Electric Vehicle
FC	Fuel Cell
FCEV	Fuel Cell Electric Vehicles
FCH JU	Fuel Cells and Hydrogen Joint Undertaking
GDL	Gas Diffusion Layer
GPU	Graphics Processing Unit
GWh	Giga-Watt Hour
HDS	High-Demand Scenario
ITO	Indium tin oxide thin film in PV
LCO	Lithium Cobalt Oxide
LENS	Laser Engineering Net Shaping
LDS	Low-Demand Scenario
LMD	Laser Metal Deposition
LPD	Layer Plastic Deposition
LTS	Long-Term Strategy
MDS	Medium-Demand Scenario
MW	Megawatt
NdFeB	Neodymium-iron-boron (magnets)
NCA	Lithium Nickel Cobalt Aluminium Oxide
NMC	Lithium Nickel Manganese Cobalt Oxide
PGM	Platinum Group Metal
PHEV	Plug-In Hybrid Electric Vehicle
PM	Permanent Magnet
PMSG	Permanent Magnet Synchronous Generator
PV	Photovoltaic
REE	Rare Earth Element; H=Heavy; L= Light
SLC	Selective Laser Cladding
SLM	Selective Laser Melting
SLS	Selective Laser Sintering
UAV	Unmanned Aerial Vehicles
WAAM	Wire and Arc Additive Manufacturing



Annexes



Annex 1 – Methodological notes

Executive summary and all 2030 and 2050 raw materials demand visualisations

For this study, the quantification for the selected materials as visualised in the chart on the right is based on three scenarios: the baseline scenario (medium demand scenario, MDS), the raw materials consumption 'optimistic' scenario ('low-demand – high substitution' scenario, LDS), and the materials consumption 'pessimistic' scenario ('high demand – low substitution' scenario, HDS). MDS is characterised by average assumptions on the sensitivity drivers, and it depicts the most likely and credible scenario in the light of current technology and market trends. LDS and HDS are conceived to include simultaneously all more radical assumptions for the sensitivity drivers. These scenarios should not be considered as likely or realistic, but rather as the reasonable higher and lower boundaries of future materials demand.

Capacity trends combined with the assumptions on lifetime allow calculating the annually deployed capacity, expressed in GW or number of vehicles. Market shares determine how the capacity is split among the different technologies, each characterised by a specific set of materials. Finally, the material intensity indicates the quantity of material per unit of capacity or per technology.

Capacity scenarios are common for renewables and vehicles, which guarantees consistency to the exercise. Specific assumptions apply to the other sensitivity drivers, as described in Section 2 for each individual technology.

The future capacities of renewables and vehicles derive from policy-relevant scenarios. LDS and MDS are derived from the EU Long-Term Strategy (LTS) – A Clean Planet for All and the third one is a JRC-TIMES scenario developed for the Low Carbon Energy Observatory (LCEO) project.

How to interpret the graphs?

The vertical axis of the 2030/2050 graphs displays the additional material demand for the selected application/technology or sector only, in comparison to the average total EU consumption derived from the assessment for the 2020 list of CRMs. More specific, in order to use the most comprehensive and harmonised baseline, the average of the global material supply is used as a starting point since this is the best documented value available for all materials. In order to make a fair analysis, the increase in EU consumption is compared to the EU share of this global supply, estimated via the economic share, being 22 % of GDP. Since the data from 2020 list of CRMs is based on the 5-year average for 2012-2016, the '1x' reference point in the graph equals this value (i.e. 22 % of the global supply).

The values presented are additional demand, meaning that when a value of 1 is presented, this means for example an increase in total consumption of this material with 6 000 t, in addition to the 2015 total consumption. A value less than 1 does not mean a reduction, e.g. 0.50 means 50% more materials or 1.5 times the current demand.

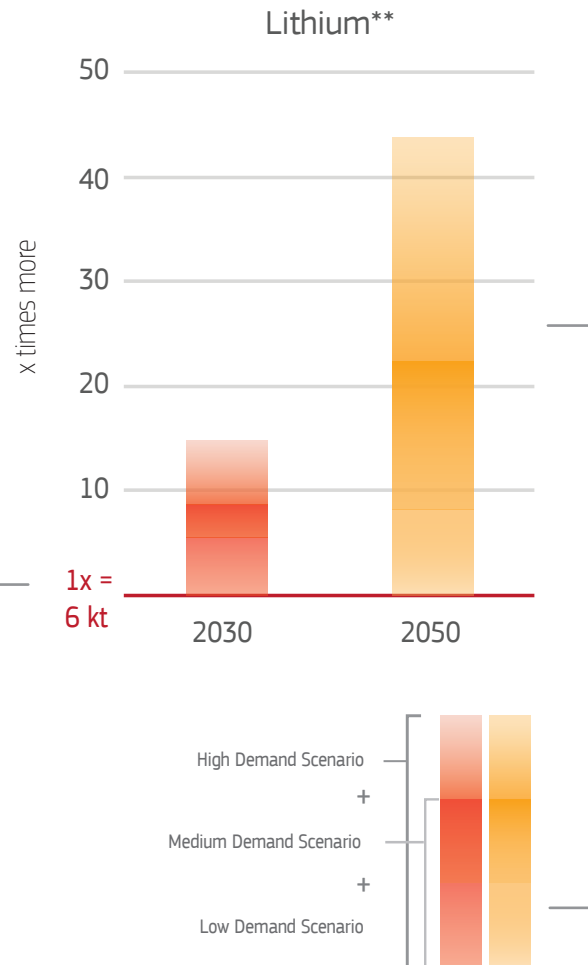

Different baseline options

Obviously, different choices for the baseline for comparison are possible. In the next data tables in Annex 2, also alternative values are presented, based on two other main sources:

- ▶ The average EU consumption determined in the 2020 CRM assessment. This value can differ from the 22 % GDP share x global supply number due to non-documented flows, recycling flows and/or missing trade data.
- ▶ The second alternative is the EU production data, where available. Obviously, the EU is a net importer, therefore for most materials the 'x times extra' values will be dramatically higher in this case. The values however provide an indication of (the lack of) self-sufficiency needed in relation to the estimated future demand for raw materials.
- ▶ The reference values for the baseline are listed in the next table

Reference values for the baseline

Material	Average of 2012-2017 global supply x 22% EU share of global GDP in tonnes		Selected stage for the analysis	EU consumption in tonnes <i>(less reliable for some materials)</i>		EU domestic production in tonnes	
	Stage 1	Stage 2		Stage 1	Stage 2	Stage 1	Stage 2
Aluminium	NA	12 000 000	2 (refined)	NA	5 000 000	NA	2 000 000
Borate	200 000	40 000	2 (refined)	20 000	40 000	NA	NA
Cadmium	NA	5 000	2 (refined)	NA	700	NA	2 000
Chromium	2 000 000	1 000 000	2 (refined)	400 000	800 000	300 000	300 000
Cobalt	30 000	20 000	1 (ores)	10 000	20 000	2 000	10 000
Copper	4 000 000	5 000 000	1 (ores)	1 000 000	3 000 000	790 000	3 000 000
Dysprosium	200	NA	1 (ores)	10	5	NA	NA
Gallium	NA	50	2 (refined)	NA	30	NA	20
Germanium	NA	30	2 (refined)	NA	20	NA	10
Indium	NA	200	2 (refined)	NA	60	NA	70
Iron ore	449 000 000	357 000 000	1 (ores)	128 000 000	164 000 000	36 000 000	156 000 000
Lithium	7 000	6 000	2 (refined)	1 000	2 000	100	NA
Manganese	4 000 000	3 000 000	1 (ores)	300 000	500 000	32 000	400 000
Molybdenum	60 000	NA	1 (ores)	30 000	30 000	NA	4 000
Natural graphite	300 000	NA	1 (ores)	90 000	NA	2 100	NA
Neodymium	4 000	NA	1 (ores)	60	40	NA	NA
Nickel	500 000	400 000	1 (ores)	60 000	400 000	46 800	100 000
Platinum	NA	40	2 (refined)	NA	50	NA	1
Praseodymium	1 000	NA	1 (ores)	20	20	NA	NA
Selenium	NA	700	2 (refined)	NA	1 000	NA	1 000
Silicon metal	NA	600 000	2 (refined)	NA	400 000	NA	200 000
Silver	6 000	7 000	1 (ores)	3 000	800	2 000	4 000
Tellurium	NA	80	2 (refined)	NA	30	NA	30
Terbium	50	NA	1 (ores)	20	5	NA	NA
Zinc	3 000 000	3 000 000	1 (ores)	2 000 000	2 000 000	725 500	2 000 000

*NA = Not available data.

The 2020 CRM assessment of supply risk per material is either based on the global ore supply (stage 1) or global supply of refined (stage 2). For consistency, the same selection is

applied for this report. All materials where stage 2 is selected are marked in the legend.

Executive summary – Supply risk and raw material occurrences Sankey diagrams

(Figure 2, Figure 47, Figure 48, Figure 52, Figure 53, Figure 57 and Figure 58). The Sankey diagram of Figure 2 represents on the left side the occurrence of these 25 materials grouped in five classes of supply risk (five colours for five risk classes). For each material evaluated, a substantiated estimate is made by the authors on the share of material used in each

technology, based on the current and future scenarios presented in Chapter 2. The multiplication of the occurrence of each raw material with these percentages determines the size of the flow of materials in the diagram. The same approach is applied for the share of each technology feeding into the three sectors visualised on the right



Figure A1. Overview of the parameters used in assessing the supply bottlenecks along the value chain.

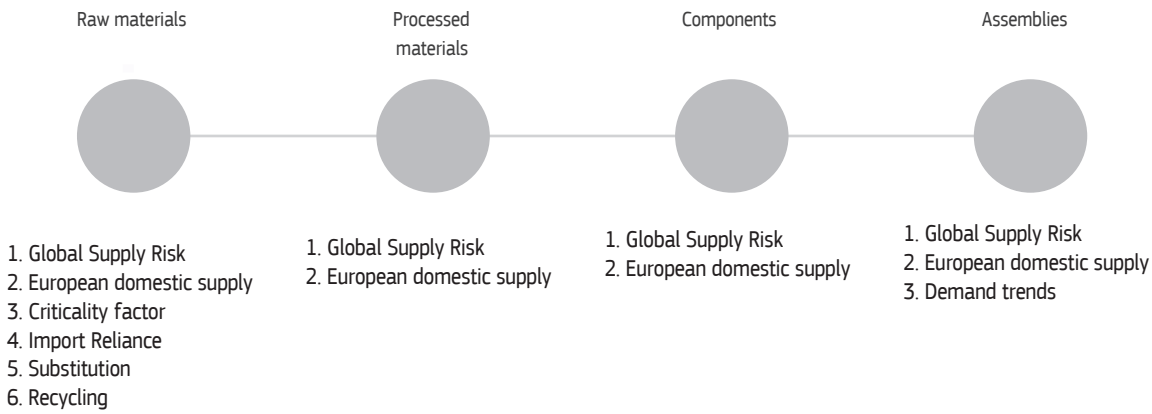

Section 1.2 Approach – Assessment of supply chain bottlenecks

The potential bottlenecks in the supply chains of the strategic technologies selected for this study were assessed through a tailored methodology using several parameters for each step of the supply chain (Figure A1).

The potential supply bottlenecks and country supply share along the value chain for all technologies were assessed according to the methodology used in the JRC study (JRC, 2019b).

Six parameters are used to evaluate the potential supply risks at the level of raw materials, namely: (1) global supply risk; (2) European production (domestic supply); (3) criticality factor (whether a material is flagged as critical in the 2017-2020 CRM list); (4) import reliance of Europe for a particular raw material; (5) substitution; and (6) recycling. For steps 2, 3 and 4 in the supply chain, two parameters are used: (1) global supply risk; and (2) European production (domestic supply). The global supply risk for all steps has been determined using the Herfindahl-Hirschman Index (HHI), based on concentration of supply. The European domestic supply corresponds to the European shares determined during the supply chain analysis. An additional parameter – demand trends – is considered at the last step in the supply chain, indicating demand increases forecast for the future.

The indicators are normalised in the range of 0 to 1; lower values indicate a relatively higher degree of supply risk. The results are presented visually in the form of a traffic-light matrix. The following two marginal cases are distinguished.

- ▶ Red area (corresponding to value 0), indicating a very high supply risk and the presence of substantial supply issues combined with a limited ability to adapt or tackle them due to the nature of the impact/risk.
- ▶ Green area (corresponding to value 1), indicating the best case scenario, or no detectable supply issues.

Intermediate values, represented by yellow, orange or various intensities of green, indicate that a potential supply issue/risk is detectable with medium to low confidence.

The materials identified for each technology contribute to each parameter with an equal weight through an arithmetic mean before being combined and scaled from 0 to 1.

The key country producers for raw materials step was calculated by using the country share for material. For other steps the country share was calculated through a simplified approach which takes into account the headquarters location. However, such an approach could introduce some discrepancy into the results of the final supply chain shares, since they can differ from the supply shares calculated using the geographical location where actual production takes place.

Low, medium and high demand scenario definitions

The materials demand estimations are based on three scenarios: low demand scenario (LDS), medium demand scenario (MDS) and high demand scenario (HDS) according to a JRC methodology (JRC, 2020a). MDS is characterised by average assumptions on the sensitivity drivers, while LDS and HDS are conceived to include simultaneously all the radical assumptions on the sensitivity drivers. These two scenarios should not be considered as likely or realistic, but rather as the reasonable higher and lower boundaries of materials demand futures.

The main sensitivity drivers considered in this study are:

- ▶ Size of technology deployment/sectors (e.g. electricity generation capacities for renewables, size of fleets for e-mobility);
- ▶ Lifetime of technologies (e.g. of energy plants for renewable, of vehicles for e-mobility);
- ▶ Sub-technology market shares;
- ▶ Material intensity in technologies.

Capacity trends combined with the assumptions on lifetime allow calculating the annually deployed capacity, expressed in GW or number of vehicles. Market shares determine how the capacity is split among the different technologies, each characterised by a specific set of materials. Finally, material intensity indicates the quantity of material per unit of capacity or per vehicle.

Capacity scenarios are common for renewables and vehicles, which guarantees consistency to the exercise. Specific assumptions apply to the other sensitivity drivers, as described in the relevant sections in Chapter 2.

The future capacities of renewables and vehicles derive from policy-relevant scenarios. LDS and MDS are from the EU Long-Term Strategy (LTS – A Clean Planet for All) (European Commission, 2018) and the third one is a JRC-TIMES scenar-

io developed for the Low Carbon Energy Observatory (LCEO) project (Carlsson et al., 2020). In particular:

- ▶ LDS – LTS Baseline: considers the EU legally binding targets by 2030 and targets a 64 % reduction of GHG emissions by 2050
- ▶ MDS – LTS 1.5°C Technical: considers the EU legally binding targets by 2030 (hence it is identical to the LTS Baseline until this date) and targets a 100 % reduction of GHG emissions by 2050;
- ▶ HDS – JRC-TIMES ZeroCarbon: almost complete decarbonisation by 2050 and stronger decarbonisation in 2030 than LTS in line with the 55 % objective depicted in the EU Green Deal (European Commission, 2019).

Section 2.1 Batteries

Converting demand scenarios to raw materials amounts for batteries for vehicles

Key underlying parameters used in Section 2.1 include variations in time of vehicle lifetimes, battery capacities, chemistries share and material content of various chemistries (expressed in kg of materials per kWh). For instance, nickel-rich battery chemistries with lower cobalt content like NMC 811 are already available in the market and increasingly replacing NMC 111 (Leader et al., 2019). As far as possible, assumptions have been aligned with previous JRC reports like (JRC, 2018c). Historic time series for all batteries placed on the market, in stock and as waste generated potential are provided online for the EU-28 in the JRC-RMIS (JRC, 2020b).

Section 2.2 Fuel cells

About 28 grams of platinum (e.g. 0.25 g/kWh of platinum is used in the 113 kW FC engine of the Toyota Mirai FCV) used as an assumption for all FC vehicles.

The HDS considers a rapid uptake of FC vehicles in the EU starting from 2030 and a saturation of the market in 2040. The slowest uptake of FCEVs is assumed by the LDS, where FCEVs should account for only about one fourth of the full EVs fleet in 2050. The demand of platinum embedded in the FCEVs is derived considering the amount of FCEVs placed on

Converting demand scenarios to raw materials amounts for energy storage systems

The demand of materials for Li-ion batteries in ESS is derived considering the penetration rate of Li-ion batteries, the variation of chemistries and the materials content per chemistry along time. Since the Li-ion batteries showed a rapid growth in the last decade (IRENA, 2017; JRC, 2018a), scenarios consider a linear increase of the penetration rate of Li-ion batteries in ESS from the current 57% to the following levels in 2050: 60% in the LDS, 70% in the MDS and 80% in the HDS scenario.

market and the variation of the platinum content along time (due to material efficiency improvement) for the three scenarios. For instance, the LDS a reduction of about 50% of platinum in 2050 compared to 2030, while the reduction for the MDS is about 40% and for the HDS, about 20%.

The estimate of the platinum demand for FCs in storage systems take into account the variation of the platinum content in time: it is assumed 60% (LDS), 33% (MDS) and 20% (HDS) reductions in 2050 compared to 2030 (Hao et al., 2019).

Section 2.3 Wind

Wind capacities and lifetimes

Manufacturers normally guarantee a lifetime longer than 20 years. On the other hand, some turbines have reached an operational lifetime of 30 years. Thus 20 years is assumed to be the lifetime in HDS, while 30 years is chosen for LDS. In fact, shorter lifetime implies higher replacement rate, hence higher demand, and vice versa (Garrett and Rønde, 2017).

The lifetime of offshore wind turbines is 5 years longer on average, hence 35 years have been assumed for LDS, 30 years for MDS, and 25 years for HDS (JRC, 2019c).

The combination of these lifetime values with the capacity scenarios allows calculating the yearly deployed capacity, which is the driver of materials demand (Figure 21).

Materials in wind turbines

Low, medium and high demand scenarios for the market shares have been defined based on the penetration of permanent magnet generators. In detail, the evolution of market shares is as follows. An extrapolation based on historical time series was applied to LDS, also considering the uptake of high-temperature superconductors (HTS) generators. The same extrapolation as for LDS has been applied to MDS, but



modified to accommodate the continuous deployment of direct drive generators with permanent magnets (notably direct drive) in the offshore sector and, to a lesser extent, in the onshore sector. Finally, for HDS mixes of sub-technologies in future energy scenarios are assumed to match today's average values for the offshore, while for the onshore, technology replacement rates are based on historical time series (the same as before) modified to accommodate a higher deployment of turbines with permanent magnets (again, notably direct drive).

A moderate material intensity reduction is considered for the general materials, i.e. concrete, steel, plastic, glass/carbon

Section 2.4 Traction motors

Assumptions concerning the reduction of materials in electric motors consider material efficiency, dematerialisation (better motor design) and possible component substitution (motor without PMs). For example, the low demand scenario considers much lower content in rare earths (reduction of 30% in 2030 and of 40% compared to 2015 composition, except for dysprosium that is cut by 66% by 2030 and 75% by 2050). Moderate demand scenario for rare earths considers 20%

Section 2.5 PV

PV capacities

The EU import dependence on PV modules as derived from the difference between apparent consumption and the EU production is estimated between 65% and 80% (Trinomics, 2019). This dependence is expected to increase in the near future due to the growth of the European PV market.

LDS, MDS and HDS scenarios for the technology market shares are defined in the perspective of thin-film technologies. MDS depicts a substantial conservation of the current market shares, with a moderate growth of thin-film technologies that reach 10% overall in 2050 (4.5% each for CdTe and CIGS, 1% for a-Si). HDS considers an expansion to 10% both for CdTe and CIGS, and to 3% for a-Si. This means that c-Si technologies are expected to lead the market (77% share in 2050) even in the most optimistic scenario for thin-films. Instead, LDS considers a further expansion of c-Si, up to 99% in 2050. Thin-film technologies maintain a symbolic 1%: 0.5% each for CdTe and CIGS, while a-Si progressively disappears from the market.

The same material intensity reduction as for wind energy is considered for the general materials: 2050 material intensity is 80%, 90%, and 100% of the current values in LDS, MDS, and HDS, respectively. A more significant decrease is expected for the material intensity of materials used in solar cell, and in particular the material intensity is forecasted to be

composites, Al, Cr, Cu, Fe, Mn, Mo, Ni, and Zn. In particular, values in 2050 are equal to 80%, 90%, and 100% of the current values in LDS, MDS, and HDS, respectively.

Specific materials, essentially used in permanent magnets, are B, Dy, Nd, Pr, and Tb. Although with some exception, these materials are common across the considered technologies. For these materials, the following hypotheses on material intensity have been defined: a 5%-yearly reduction for LDS, a 2%-yearly reduction for MDS, and constant material intensity for HDS.

and 25% cuts by 2030 and 2050 respectively, except for dysprosium (– 33% in 2030 and – 50% in 2050). High demand scenarios consider a reduction of consumption of rare earths per motor with same functionality of 10% in 2030 and 15% by 2050. For other materials, the following material intensity assumptions were used: stability for high demand scenario, – 10%, – 5% by 2030 and – 20% and – 10% by 2050 for low and medium demand scenarios.

decreasing even in the High Demand Scenario. The values adopted in this work are mostly based on (Nassar et al., 2016).

Materials in PV

The most commonly semiconductor materials used in PV systems are silicon and compounds of cadmium telluride (CdTe), copper indium gallium selenide ($\text{CuIn}_x\text{Ga}_{1-x}\text{Se}_2$ - CIGS), gallium arsenide (GaAs) and perovskite structure based on hybrid organic-inorganic metal halides. The efficiency of conversion of solar energy into electricity is the key driver to reduce the cost of the solar energy. Research in understanding the chemistry behind the material growth and the physics behind the device operation led to an unprecedented development of PV materials and achievement of high performance and reliability at lower cost. Besides the five PV materials mentioned above (silicon, CdTe, CIGS, GaAs and perovskite), which show efficiencies above 20%, many other materials with lower efficiencies have been developed such as micro/nanocrystalline and amorphous silicon, copper zinc tin sulphide ($\text{Cu}(\text{Zn},\text{Sn})(\text{S},\text{S})_2$ - CZTS), dye-sensitized TiO_2 , organic polymer materials and quantum dot solids (Polman et al., 2016). Despite the progress made over the years in increasing the efficiency of solar cells there is much room for improvement of PV materials. This improvement will enable PV technology for large-scale applications and power generation for the utility grid and its penetration into the energy system.

Annex 2 – Data tables

The following data tables show the specific values for the 2030 and 2050 LDS, MDS and HDS scenarios. Also the (interpolated) value for 2018 as the most recent year with

complete consumption data for the materials in the specific application only is listed.

Section 2.1 Batteries

Scenario data for vehicles:

Year	LDS	MDS	HDS	Year	LDS	MDS	HDS
	in million vehicles				in million vehicles		
2015	-	-	10	2031	40	40	70
2016	-	-	10	2032	50	50	80
2017	10	10	10	2033	50	60	80
2018	10	10	10	2034	60	70	90
2019	10	10	10	2035	60	80	100
2020	10	10	10	2036	70	90	100
2021	10	10	20	2037	70	100	110
2022	20	20	20	2038	80	100	120
2023	20	20	30	2039	80	110	120
2024	20	20	30	2040	90	120	130
2025	20	20	40	2041	90	130	140
2026	30	30	40	2042	100	140	150
2027	30	30	50	2043	100	150	160
2028	30	30	50	2044	110	160	170
2029	30	30	60	2045	110	160	180
2030	40	40	60	2046	120	170	190
				2047	120	180	190
				2048	130	190	200
				2049	130	200	210
				2050	140	210	220

Materials for batteries for e-mobility (see Figure 10):

Assessed material	Year	LDS [tonnes]	MDS [tonnes]	HDS [tonnes]
Cobalt	2030	38 000	67 000	120 000
	2050	38 000	110 000	290 000
Lithium	2030	32 000	51 000	90 000
	2050	48 000	130 000	260 000
Nickel	2030	200 000	280 000	440 000
	2050	420 000	1 100 000	1 500 000
Manganese	2030	29 000	63 000	120 000
	2050	19 000	83 000	260 000
Graphite	2030	340 000	500 000	820 000
	2050	700 000	1 800 000	2 700 000



Materials for batteries for renewables (see Figure 12):

Assessed material	Year	LDS [tonnes]	MDS [tonnes]	HDS [tonnes]
Cobalt	2030	13 000	16 000	25 000
	2050	63 000	44 000	140 000
Lithium	2030	10 000	10 000	16 000
	2050	45 000	28 000	77 000
Nickel	2030	32 000	32 000	51 000
	2050	160 000	97 000	270 000
Manganese	2030	32 000	36 000	44 000
	2050	59 000	41 000	130 000
Graphite	2030	99 000	110 000	160 000
	2050	480 000	290 000	780 000

Historic time series for all batteries placed on the market, in stock and as waste generated potential are provided online for the EU-28 in the JRC-RMIS (JRC, 2020b).

Section 2.2 Fuel cells

Materials for FCs for e-mobility (see Figure 17):

Assessed material	Year	LDS [tonnes]	MDS [tonnes]	HDS [tonnes]
Platinum	2030	2	10	20
	2050	5	30	50

Materials for FCs for renewables (see Figure 17):

Assessed material	Year	LDS [tonnes]	MDS [tonnes]	HDS [tonnes]
Platinum	2030	0	0	1
	2050	1	2	10

Section 2.3 Wind

Materials for wind turbines for renewables (see Figure 22):

Assessed material	Year	LDS [tonnes]	MDS [tonnes]	HDS [tonnes]
Aluminium	2030	18 000	33 000	60 000
	2050	22 000	63 000	140 000
Borates	2030	10	50	140
	2050	10	80	360
Chromium	2030	8 000	16 000	31 000
	2050	10 000	32 000	74 000
Copper	2030	35 000	76 000	150 000
	2050	47 000	150 000	350 000
Dysprosium	2030	60	210	540
	2050	30	310	1 400
Manganese	2030	12 000	25 000	47 000
	2050	15 000	48 000	110 000
Molybdenum	2030	1 700	3 400	6 500
	2050	2 100	6 600	15 000
Neodymium	2030	470	1 900	5 000
	2050	260	2 900	13 000
Nickel	2030	5 900	11 000	21 000
	2050	7 400	21 000	48 000
Praseodymium	2030	80	340	890
	2050	40	510	2 300
Steel	2030	300 000	620 000	1 200 000
	2050	380 000	1 200 000	2 800 000
Terbium	2030	20	70	180
	2050	10	110	450
Zinc	2030	80 000	170 000	330 000
	2050	110 000	330 000	760 000



Section 2.4 Traction Motors

Materials for traction motors for e-mobility (see Figure 26):

Assessed material	Year	LDS [tonnes]	MDS [tonnes]	HDS [tonnes]
Aluminium	2030	88 000	130 000	190 000
	2050	210 000	420 000	510 000
Borates	2030	70	120	180
	2050	160	360	440
Copper	2030	55 000	83 000	120 000
	2050	130 000	260 000	320 000
Dysprosium	2030	220	410	560
	2050	500	1 100	1 400
Neodymium	2030	960	1 300	1 700
	2050	2 100	3 300	4 100
Praseodymium	2030	320	430	550
	2050	690	1 100	1 400
Silicon metal	2030	28 000	45 000	69 000
	2050	64 000	140 000	170 000
Steel	2030	610 000 000	910 000 000	1 300 000 000
	2050	1 400 000 000	2 900 000 000	3 500 000 000

Section 2.5 PV

Materials for PVs for renewables (see Figure 31):

Assessed material	Year	LDS [tonnes]	MDS [tonnes]	HDS [tonnes]
Aluminium	2030	83 000	200 000	520 000
	2050	110 000	410 000	1 300 000
Cadmium	2030	5	20	220
	2050	1	30	600
Copper	2030	51 000	120 000	320 000
	2050	68 000	250 000	800 000
Gallium	2030	0	2	20
	2050	0	5	40
Germanium	2030	1	5	30
	2050	0	10	100
Indium	2030	1	10	60
	2050	0	20	170
Selenium	2030	5	20	140
	2050	1	30	350
Silicon metal	2030	23 000	71 000	216 000
	2050	18 000	109 000	399 000
Silver	2030	50	160	680
	2050	20	110	660
Tellurium	2030	5	20	260
	2050	1	40	690

Figures and tables

Figure 1: Critical raw materials use in different technologies in the EU in 2030 and 2050	9
Figure 2: Semi-quantitative representation of flows of raw materials and their current supply risks	10
Figure 3: Identified supply risks for Europe	12
Figure 4: Strategic technologies and sectors for the EU economy and their interlinkages	15
Figure 5: Supply risk indication	16
Figure 6: Critical and non-critical raw materials use in different technologies	17
Figure 7: Raw materials used in batteries	19
Figure 8: Li-ion batteries supply risks, bottlenecks and key players along the supply chain.	20
Figure 9: EU fleet of electric vehicles containing batteries according to the three explored scenarios	21
Figure 10: EU annual material demand for batteries in EVs in 2030 and 2050	21
Figure 11: EU battery storage capacity according to the three explored scenarios	22
Figure 12: EU annual material demand for ESS batteries in 2030 and 2050	22
Figure 13: Overview of various FC types and operation conditions.	24
Figure 14: Relevant raw materials used in in fuel cells (FCs)	25
Figure 15: FCs and Hydrogen technologies supply risks, bottlenecks and key players along the supply chain.	26
Figure 16: EU fleet of fuel cell electric vehicles (FCEVs) according to the three explored scenarios	27
Figure 17: EU annual material demand for platinum in FC electric vehicles in 2030 and 2050	27
Figure 18: Raw materials used in wind turbines	29
Figure 19: Wind turbines supply risks, bottlenecks and key players along the supply chain.	30
Figure 20: Onshore and offshore wind capacity in the three explored scenarios.	31
Figure 21: Onshore and offshore wind annual deployed capacity in the three explored scenarios.	31
Figure 22: EU annual material demand for wind power in 2030 and 2050.	32
Figure 23: Raw materials in traction motors	34
Figure 24: Traction motors supply risks, bottlenecks and key players along the supply chain.	35
Figure 25: Fleet of vehicles using electric motors according to the three explored scenarios.	36
Figure 26: EU annual material demand for traction motors in 2030 and 2050.	36
Figure 27: Raw materials used in solar PV technologies	38
Figure 28: Solar PV supply risks, bottlenecks and key players along the supply chain.	39
Figure 29: Solar PV total installed capacity in the three explored scenarios.	40
Figure 30: PV annually installed capacity in the three explored scenarios.	40
Figure 31: EU annual material demand for PV in 2030 and 2050.	41
Figure 32: Relevant raw materials in robotics	43
Figure 33: Robotics supply risks, bottlenecks and key players along the supply chain	44
Figure 34: Country production share of service robots and exoskeletons	45
Figure 35: Drones applications	47
Figure 36: Raw materials in drones	48
Figure 37: Drones supply risks, bottlenecks and key players along the supply chain.	49
Figure 38: Forecast number of drones per type of activity.	50



Figure 39. Raw materials in 3D printing.	51
Figure 40. 3D printing supply risks, bottlenecks and key players along the supply chain.	52
Figure 41. Projected 3D printing market.	53
Figure 42. Digitalisation and sustainable production and consumption.	55
Figure 43. Estimated materials intensity factors for different memory technologies.	56
Table 2. CRM significance indicators for smartphones, laptops and desktop PCs.	57
Figure 44. Raw materials in digital technologies..	57
Figure 45. Digital technologies: key players along the supply chain	58
Figure 46. Gross inland consumption of energy in the EU for various timelines and scenarios	60
Figure 47. Relevant materials and technologies relevant to the renewable energy sector	61
Figure 48. List of critical and non-critical raw materials used for renewables ranked by their 2020 supply risk	61
Figure 49. Materials supply bottlenecks for seven technologies relevant to the renewable sector	62
Figure 50. EU annual material demand for renewables in 2030 and 2050	63
Figure 51. Forecasts of vehicles technologies diffusion in the EU 2015-2050	65
Figure 52. Relevant materials and technologies to the e-mobility sector	65
Figure 53. List of materials used in e-mobility with their 2020 supply risk	66
Figure 54. Potential supply risks in the value chains relevant to the EU e-mobility sector	66
Figure 55. EU annual material demand for e-mobility sector in 2030 and 2050	67
Figure 56. Relevant materials and technologies to the defence and aerospace sectors	69
Figure 57. Relevant raw materials used in defence applications.	70
Figure 58. Use in defence applications and supply risk of raw materials used by the EU defence industry.	71
Figure 59. Estimated composites loading in various defence aeronautic applications	72
Figure 60. Materials used in different parts of the combat aircraft Rafale	73
Figure 61. Potential supply risks in the value chains and key suppliers relevant to the European defence sector	74
Figure 62. Key players in the supply of raw materials used in defence sector	75
Figure 63. EU annual material demand for e-mobility and renewables combined in 2030 and 2050	76
Figure 64. List of critical and non-critical raw materials use in different technologies with their supply risk	81
Figure 65. Key suppliers for eight technologies in country shares	82
Table 3. Reference baseline values	88
Figure A1. Overview of the parameters used in assessing the supply bottlenecks along the value chain.	89

GETTING IN TOUCH WITH THE EU

In person

All over the European Union there are hundreds of Europe Direct information centres. You can find the address of the centre nearest you at: <http://europa.eu/contact>

On the phone or by email

Europe Direct is a service that answers your questions about the European Union. You can contact this service:

- by freephone: 00 800 6 7 8 9 10 11 (certain operators may charge for these calls),
- at the following standard number: +32 22999696 or
- by email via: <http://europa.eu/contact>

Finding information about the EU

Online

Information about the European Union in all the official languages of the EU is available on the Europa website at: <http://europa.eu>

EU publications

You can download or order free and priced EU publications from EU Bookshop at: <http://publications.europa.eu/eubookshop>. Multiple copies of free publications may be obtained by contacting Europe Direct or your local information centre (see <http://europa.eu/contact>).

EU law and related documents

For access to legal information from the EU, including all EU law since 1951 in all the official language versions, go to EUR-Lex at: <http://eur-lex.europa.eu>

Open data from the EU

The EU Open Data Portal (<http://data.europa.eu/euodp>) provides access to datasets from the EU. Data can be downloaded and reused for free, both for commercial and non-commercial purposes.

